

# GARY Collection™

*Complete Line of Reusable and Recyclable Stock Rigid Plastic Packaging*



# Gary Plastic Packaging Corp.

## The Source, The Solution.

In a world filled with confusing choices we hope this catalog makes it easier for you to select the right container for your product.

*Consider the advantages of a rigid plastic container. It protects, displays and permanently houses your product.*

The Gary Collection offers both crystal clear, tutone and opaque containers to showcase your product to its best advantage. Bright graphics imprinted on the container identify and distinguish your product inexpensively and attractively. Foam and flocked paperboard inserts perfectly nest and protect your product while enhancing the overall appearance of your package.

And... in a world where the continuing concerns of our environment affects us all, our plastic container is both reusable and recyclable.

Gary manufactures over **350** stock sizes to choose from. This includes:

1. rectangular hinged boxes
2. unhinged boxes with friction-fit covers
3. unhinged round boxes
4. hinged compartment boxes
5. the Omni Collection - rectangular showcase boxes with raised and flush covers
6. specialty boxes
7. **New** blow molded squeeze bottles

### **Gary, The Source...**

Gary Plastic Packaging Corp. has been a manufacturer of stock rigid plastic containers since 1963. Today, we offer you the largest selection of stock rigid plastic containers in the industry.

Our facilities include 300,000 sq. feet of office, manufacturing and warehouse space. We have 25 high



speed injection molding machines, and a complete decorating department for hot stamping, silk screening and pad printing.

Our design department is available to work with you to create the package you are looking for- whether it's for an entire production run or for a market test.

If you require a custom designed container our engineering staff will work with you throughout the entire project. Our qualified staff will take you step by step from design and engineering, through tooling and injection molding to create the perfect container for your product.

We do all our own foam slitting, die cutting, bagging and shrink wrapping in house.

The result of our capabilities is that we have successfully filled many different kinds of orders, both large and small helping to improve our customers sales efforts.

*Let Gary fill your packaging needs.*

*A quality product, prompt delivery and expert service are why we've been the source for packaging since 1963.*

: 1340 Viele Avenue, Bronx, NY 10474 • 718-893-2200 • Fax 877-855-5554 • **800-221-8150**

3605 W. MacArthur Ave., Suite 714, Santa Ana, CA 92704 • 714-556-4121 • Fax 714-545-5780 • **800-222-4279**

Visit our Web Site: [www.plasticboxes.com](http://www.plasticboxes.com) • E-mail address: [sales@plasticboxes.com](mailto:sales@plasticboxes.com)

For static dissipative and conductive packaging and foam. Visit [www.stat-tech.com](http://www.stat-tech.com)

## Prices & Ordering

**Important Note:** Sizes listed in this catalog are approximate inside dimensions. Please use actual sample boxes for figuring inserts or outer packaging.

### Prices

- Prices are per thousand quantities, except where otherwise noted.
- For price quotations on quantities in excess of those shown, please call our sales office at 718-893-2200.
- All prices are quoted F.O.B. Bronx, NY.
- Prices are subject to change without notice.
- All orders are subject to our standard conditions of sale.
- Each item ordered under \$100, exclusive of freight, is subject to a \$10 handling charge.
- Projected orders up to 12 months assure timely delivery.

### Shipment

- Unless otherwise specified, we will use our discretion in routing shipments. We regularly use common carriers, UPS and UPS 100 Wt., whichever is most efficient.
- Each carton contains only one color.

### Terms

- Unrated firms: Payment plus freight with order. To establish credit, please submit two trade and one bank reference. Allow two weeks for this process.
- Rated firms: Net 30 days.
- No C.O.D. shipments.
- Make checks payable to Gary Plastic Packaging Corp.
- Visa, Mastercard and American Express are accepted.

### Shortages

- Claims for merchandise which is lost or damaged in transit must be filed with the carrier. Damaged merchandise should not be returned to Gary Plastic Packaging Corp. Upon request, Gary Plastic Packaging Corp. will assist in expediting or tracing shipments. Return shipments will not be accepted without prior authorization.

### Colors

- Stock colors: Crystal clear.
- Standard colors: Black, white, medium blue.
- Custom colors: A wide selection is available. In addition, specific colors can be matched. The charge for custom colors is a \$75 purge charge per color when the box is produced from a single mold. When two molds are required to produce the components of the container (i.e., the base and lid heights are different) or the item is a compartment box, the charge is \$150. We do not have minimum order requirements to run your choice of colors.

### Customer Service

- Please call us at **800-221-8150** or fax 877-855-5554 for any information you need on prices, samples and custom features.

## Custom Services

If you are thinking of having a customized package or custom molded product produced, we would be happy to meet with you to discuss how we can bring our full spectrum of creative and manufacturing capabilities to assist you on your project.

### Imprinting and Decorating

A whole range of imprinting and decorating services - including hot stamping, silkscreening, pad printing, decals, and in mold decoration - are available to customize your product package. Imprinting charges are calculated according to the square inch dimensions of the lid. Each box has an imprinting charge listed in the price sheet. This is a per thousand charge for a one color imprint, including the cost of the imprinting foil. There is an additional set-up charge of \$20 per order. The cost of an imprinting die, plate or screen to reproduce your order is extra. Multi-color pad printing is one of our specialties, up to four (4) colors in registration with spot colors or process printing.

### Imprinting Dies / Plates / Screens

In order to produce the imprinting die, please submit camera ready artwork. A quotation on the cost of a die will be given immediately upon receipt of artwork. One time imprinting dies are available at a lower price. Please indicate the desired location of imprint on your order. If no preference is specified, imprinting will be centered on the lid. In all cases, imprinting must be confined within an area 1/8" inside the bead of the box. A proof is faxed for your approval prior to ordering dies. We accept E-mail art @ art@garyline.com

### Imprinting Colors

We offer a choice of 50 standard foil colors, including metallic gold and silver, for hot stamping. We also offer a choice of 14 standard ink colors. PMS colors can be matched in pad printing or silkscreening.

### Inserts

For proper nesting of your product custom foam and flocked paper board die cut inserts are available. For a custom insert please send us a sample of your product. Our standard foam inserts are available in thicknesses from 1/8" to 1 1/2", pre-cut to fit your box selection. At a small additional cost, foam can be shipped inserted into your box selection. Medium blue, red, orange, yellow, purple, green, charcoal and light gray are stocked for quick delivery.

### Custom Packaging, Custom Design

Gary Plastic Packaging has an in-house design and engineering staff, with a fully equipped studio, available to work with you on your custom package or product.

### ESD Packaging

A select group of boxes and foam products are available in conductive or static dissipative materials. Please request our **Lemcen™** catalog. Visit [www.stat-tech.com](http://www.stat-tech.com) to see my complete line.

**Special Note:** Rigid Plastic Boxes Are Reusable And Recyclable

**Quick Reference Size Index**

**How To Use This Catalog**

Each box is drawn to actual inside dimensions of length, width, and overall height. On each page you will find both top and side views. This format will help guide you in selecting the right container for your product. Simply place your product on these renderings to find the correct fit. We will be happy to send samples to verify your selection.

**Delivery Service Information**

**Stockline™** indicates styles available for quick delivery in all clear or tutone (black base/clear lid). **Special Order** indicates styles which are only available in larger quantities. Minimum order varies per style. Call for further information. **All other styles** are available within our normal delivery - no minimum required. **Call customer service for further information.**

**Hinged Containers**

Size/Inches	Pg	Size/Inches.....	Pg
<b>1 x 1</b> .....	<b>3</b>	<b>3<sup>7</sup>/<sub>8</sub> x 1<sup>15</sup>/<sub>16</sub></b> .....	<b>20</b>
<b>1<sup>1</sup>/<sub>4</sub> x 1<sup>1</sup>/<sub>4</sub></b> .....	<b>3</b>	<b>4 x 1<sup>5</sup>/<sub>8</sub></b> .....	<b>20</b>
<b>1<sup>5</sup>/<sub>8</sub> x 1<sup>5</sup>/<sub>8</sub></b> .....	<b>4</b>	<b>4<sup>1</sup>/<sub>2</sub> x 1<sup>3</sup>/<sub>4</sub></b> .....	<b>21</b>
<b>2 x 1<sup>1</sup>/<sub>8</sub></b> .....	<b>4</b>	<b>4<sup>3</sup>/<sub>8</sub> x 2<sup>1</sup>/<sub>16</sub></b> .....	<b>22-23</b>
<b>2 x 2</b> .....	<b>5</b>	<b>4<sup>5</sup>/<sub>8</sub> x 2<sup>7</sup>/<sub>8</sub></b> .....	<b>23</b>
<b>2<sup>1</sup>/<sub>8</sub> x 1<sup>5</sup>/<sub>8</sub></b> .....	<b>6</b>	<b>4<sup>1</sup>/<sub>16</sub> x 4<sup>1</sup>/<sub>16</sub></b> .....	<b>24</b>
<b>1<sup>5</sup>/<sub>8</sub> x 2<sup>1</sup>/<sub>8</sub></b> .....	<b>6</b>	<b>4<sup>9</sup>/<sub>16</sub> x 4<sup>9</sup>/<sub>16</sub></b> .....	<b>25</b>
<b>2<sup>3</sup>/<sub>32</sub> x 3</b> .....	<b>7</b>	<b>4<sup>5</sup>/<sub>8</sub> x 3<sup>1</sup>/<sub>2</sub></b> .....	<b>26</b>
<b>2<sup>9</sup>/<sub>16</sub> x 2<sup>9</sup>/<sub>16</sub></b> .....	<b>7-8</b>	<b>5<sup>1</sup>/<sub>16</sub> x 3<sup>7</sup>/<sub>8</sub></b> .....	<b>27</b>
<b>2<sup>5</sup>/<sub>8</sub> x 2<sup>13</sup>/<sub>16</sub></b> .....	<b>9</b>	<b>5<sup>1</sup>/<sub>8</sub> x 3<sup>1</sup>/<sub>8</sub></b> .....	<b>28-29</b>
<b>2<sup>27</sup>/<sub>32</sub> x 1<sup>7</sup>/<sub>16</sub></b> .....	<b>9</b>	<b>5<sup>1</sup>/<sub>4</sub> x 2<sup>1</sup>/<sub>4</sub></b> .....	<b>30</b>
<b>2<sup>7</sup>/<sub>8</sub> x 1<sup>3</sup>/<sub>16</sub></b> .....	<b>10</b>	<b>5<sup>7</sup>/<sub>16</sub> x 2<sup>1</sup>/<sub>4</sub></b> .....	<b>30</b>
<b>2<sup>7</sup>/<sub>8</sub> x 2</b> .....	<b>11-12</b>	<b>5<sup>1</sup>/<sub>2</sub> x 1<sup>3</sup>/<sub>4</sub></b> .....	<b>31</b>
<b>2<sup>15</sup>/<sub>16</sub> x 1<sup>5</sup>/<sub>16</sub></b> .....	<b>12</b>	<b>5<sup>5</sup>/<sub>8</sub> x <sup>9</sup>/<sub>16</sub></b> .....	<b>32</b>
<b>3 x 3</b> .....	<b>13</b>	<b>5<sup>3</sup>/<sub>4</sub> x 1<sup>1</sup>/<sub>2</sub></b> .....	<b>32</b>
<b>3<sup>1</sup>/<sub>16</sub> x 3<sup>1</sup>/<sub>16</sub></b> .....	<b>13</b>	<b>5<sup>13</sup>/<sub>16</sub> x 1<sup>15</sup>/<sub>16</sub></b> .....	<b>33</b>
<b>3<sup>5</sup>/<sub>16</sub> x 3</b> .....	<b>14</b>	<b>6 x 2<sup>1</sup>/<sub>4</sub></b> .....	<b>33</b>
<b>3<sup>3</sup>/<sub>8</sub> x 2<sup>1</sup>/<sub>2</sub></b> .....	<b>14</b>	<b>6 x 4</b> .....	<b>34</b>
<b>3<sup>1</sup>/<sub>2</sub> x 1<sup>11</sup>/<sub>16</sub></b> .....	<b>15</b>	<b>6<sup>3</sup>/<sub>32</sub> x 1<sup>29</sup>/<sub>32</sub></b> .....	<b>35</b>
<b>3<sup>1</sup>/<sub>2</sub> x 2<sup>1</sup>/<sub>8</sub></b> .....	<b>15</b>	<b>6<sup>1</sup>/<sub>8</sub> x 2<sup>9</sup>/<sub>32</sub></b> .....	<b>35</b>
<b>3<sup>1</sup>/<sub>2</sub> x 2<sup>9</sup>/<sub>16</sub></b> .....	<b>16-17</b>	<b>6<sup>3</sup>/<sub>4</sub> x 3<sup>1</sup>/<sub>2</sub></b> .....	<b>36</b>
<b>2<sup>9</sup>/<sub>16</sub> x 3<sup>1</sup>/<sub>2</sub></b> .....	<b>18</b>	<b>7 x 3<sup>1</sup>/<sub>2</sub></b> .....	<b>37</b>
<b>3<sup>3</sup>/<sub>4</sub> x 1<sup>3</sup>/<sub>16</sub></b> .....	<b>19</b>	<b>7 x 5</b> .....	<b>38</b>
<b>3<sup>3</sup>/<sub>4</sub> x 2<sup>3</sup>/<sub>4</sub></b> .....	<b>19</b>	<b>7<sup>1</sup>/<sub>4</sub> x 3<sup>1</sup>/<sub>2</sub></b> .....	<b>39</b>

**Hinged Containers** continued

Size/Inches	Pg	Size/Inches .....	Pg
<b>7<sup>3</sup>/<sub>8</sub> x 4<sup>29</sup>/<sub>32</sub></b> .....	<b>40-41</b>	<b>9<sup>1</sup>/<sub>2</sub> x 3<sup>1</sup>/<sub>2</sub></b> .....	<b>44</b>
<b>7<sup>1</sup>/<sub>2</sub> x 1<sup>1</sup>/<sub>2</sub></b> .....	<b>42</b>	<b>9<sup>15</sup>/<sub>16</sub> x 3<sup>1</sup>/<sub>2</sub></b> .....	<b>45</b>
<b>8<sup>1</sup>/<sub>8</sub> x 6<sup>1</sup>/<sub>4</sub></b> .....	<b>43</b>	<b>10<sup>3</sup>/<sub>8</sub> x 6</b> .....	<b>46-47</b>

**Unhinged Containers**

<b>1<sup>11</sup>/<sub>16</sub> x 3<sup>3</sup>/<sub>4</sub></b> .....	<b>49</b>	<b>4<sup>5</sup>/<sub>16</sub> x 4<sup>5</sup>/<sub>16</sub></b> .....	<b>52</b>
<b>1<sup>3</sup>/<sub>4</sub> x 1<sup>3</sup>/<sub>4</sub></b> .....	<b>49</b>	<b>5<sup>1</sup>/<sub>4</sub> x 5</b> .....	<b>53</b>
<b>2 x 1<sup>1</sup>/<sub>4</sub></b> .....	<b>49</b>	<b>5<sup>1</sup>/<sub>2</sub> x 2</b> .....	<b>54</b>
<b>2 x 2</b> .....	<b>50</b>	<b>9<sup>1</sup>/<sub>2</sub> x 3<sup>1</sup>/<sub>2</sub></b> .....	<b>55</b>
<b>2<sup>1</sup>/<sub>2</sub> x 2<sup>1</sup>/<sub>2</sub></b> .....	<b>50</b>	<b>9<sup>1</sup>/<sub>2</sub> x 3<sup>9</sup>/<sub>16</sub></b> .....	<b>56-57</b>
<b>3 x 2<sup>1</sup>/<sub>8</sub></b> .....	<b>51</b>	<b>9<sup>13</sup>/<sub>16</sub> x 3<sup>7</sup>/<sub>16</sub></b> .....	<b>56-57</b>
<b>3<sup>3</sup>/<sub>8</sub> x 3<sup>3</sup>/<sub>8</sub></b> .....	<b>51</b>	<b>13<sup>1</sup>/<sub>2</sub> x 3<sup>1</sup>/<sub>2</sub> x 3<sup>3</sup>/<sub>8</sub></b> tie box	
<b>4<sup>1</sup>/<sub>4</sub> x 1<sup>1</sup>/<sub>2</sub></b> .....	<b>52</b>	<i>not pictured in catalog</i>	

**Round Containers**

<b>1<sup>3</sup>/<sub>8</sub> dia.</b> .....	<b>59</b>	<b>3<sup>5</sup>/<sub>16</sub> dia.</b> .....	<b>60</b>
<b>1<sup>5</sup>/<sub>8</sub> dia.</b> .....	<b>59</b>	<b>3<sup>3</sup>/<sub>8</sub> dia.</b> .....	<b>61</b>
<b>2<sup>1</sup>/<sub>2</sub> dia.</b> .....	<b>59</b>	<b>*4<sup>1</sup>/<sub>4</sub> dia.</b> .....	<b>62-63</b>
<b>2<sup>23</sup>/<sub>32</sub> dia.</b> .....	<b>59</b>	<b>4<sup>5</sup>/<sub>16</sub> dia.</b> .....	<b>64</b>

**Compartment Containers**

<b>2<sup>7</sup>/<sub>8</sub> x 2</b> .....	<b>66</b>	<b>7 x 5</b> .....	<b>70</b>
<b>4<sup>5</sup>/<sub>8</sub> x 3<sup>1</sup>/<sub>2</sub></b> .....	<b>67</b>	<b>8 x 4</b> .....	<b>71</b>
<b>5<sup>5</sup>/<sub>32</sub> x 3<sup>3</sup>/<sub>16</sub></b> .....	<b>68</b>	<b>10<sup>3</sup>/<sub>8</sub> x 6</b> .....	<b>72-75</b>
<b>7<sup>3</sup>/<sub>8</sub> x 4<sup>29</sup>/<sub>32</sub></b> .....	<b>69</b>		

**Omni Collection** unhinged

<b>1<sup>3</sup>/<sub>16</sub> x 1<sup>3</sup>/<sub>16</sub> x 3<sup>1</sup>/<sub>8</sub></b> .....	<b>77</b>	<b>*4 x 4 x 2</b> .....	<b>82</b>
<b>1<sup>7</sup>/<sub>16</sub> x 1<sup>7</sup>/<sub>16</sub> x 3<sup>5</sup>/<sub>16</sub></b> .....	<b>77</b>	<b>*4 x 4 x 4<sup>1</sup>/<sub>4</sub></b> .....	<b>82</b>
<b>1<sup>5</sup>/<sub>8</sub> x 1<sup>5</sup>/<sub>8</sub> x 2<sup>7</sup>/<sub>8</sub></b> .....	<b>77</b>	<b>*4 x 4 x 5<sup>1</sup>/<sub>16</sub></b> .....	<b>83</b>
<b>2<sup>5</sup>/<sub>16</sub> x 2<sup>5</sup>/<sub>16</sub> x 3<sup>1</sup>/<sub>16</sub></b> .....	<b>78</b>	<b>*4 x 4 x 7<sup>1</sup>/<sub>4</sub></b> .....	<b>83</b>
<b>2<sup>5</sup>/<sub>16</sub> x 2<sup>5</sup>/<sub>16</sub> x 4<sup>3</sup>/<sub>16</sub></b> .....	<b>78</b>	<b>*4 x 4 x 4</b> .....	<b>84</b>
<b>2<sup>5</sup>/<sub>16</sub> x 2<sup>5</sup>/<sub>16</sub> x 5<sup>1</sup>/<sub>16</sub></b> .....	<b>79</b>	<b>*4 x 4 x 10</b> .....	<b>84</b>
<b>2<sup>5</sup>/<sub>16</sub> x 2<sup>5</sup>/<sub>16</sub> x 6<sup>3</sup>/<sub>16</sub></b> .....	<b>79</b>	<b>*4 x 4 x 8</b> .....	<b>85</b>
<b>3<sup>9</sup>/<sub>16</sub> x 3<sup>9</sup>/<sub>16</sub> x 3<sup>7</sup>/<sub>8</sub></b> .....	<b>80</b>	<b>*4 x 4 x 6</b> .....	<b>85</b>
<b>*3<sup>7</sup>/<sub>16</sub> x 3<sup>7</sup>/<sub>16</sub> x 6<sup>5</sup>/<sub>16</sub></b> .....	<b>81</b>	<b>*8 x 4 x 4</b> .....	<b>86</b>
<b>*3<sup>7</sup>/<sub>16</sub> x 3<sup>7</sup>/<sub>16</sub> x 4<sup>1</sup>/<sub>2</sub></b> .....	<b>81</b>	<b>*12<sup>5</sup>/<sub>8</sub> x 8<sup>7</sup>/<sub>8</sub> x 9<sup>1</sup>/<sub>16</sub></b> .....	<b>87</b>

**Specialty Containers**

<b>Pill Box Oval</b> .....	<b>88</b>	<b>*Collectors Case</b> .....	<b>88</b>
<b>Pill Box Round</b> .....	<b>88</b>	<b>*Squeeze Bottles</b> .....	<b>88</b>
<b>Pocket Size Box</b> .....	<b>88</b>	<b>Display Goblet</b> .....	<b>88</b>

\* New

# 2 | Stock Hinged Containers

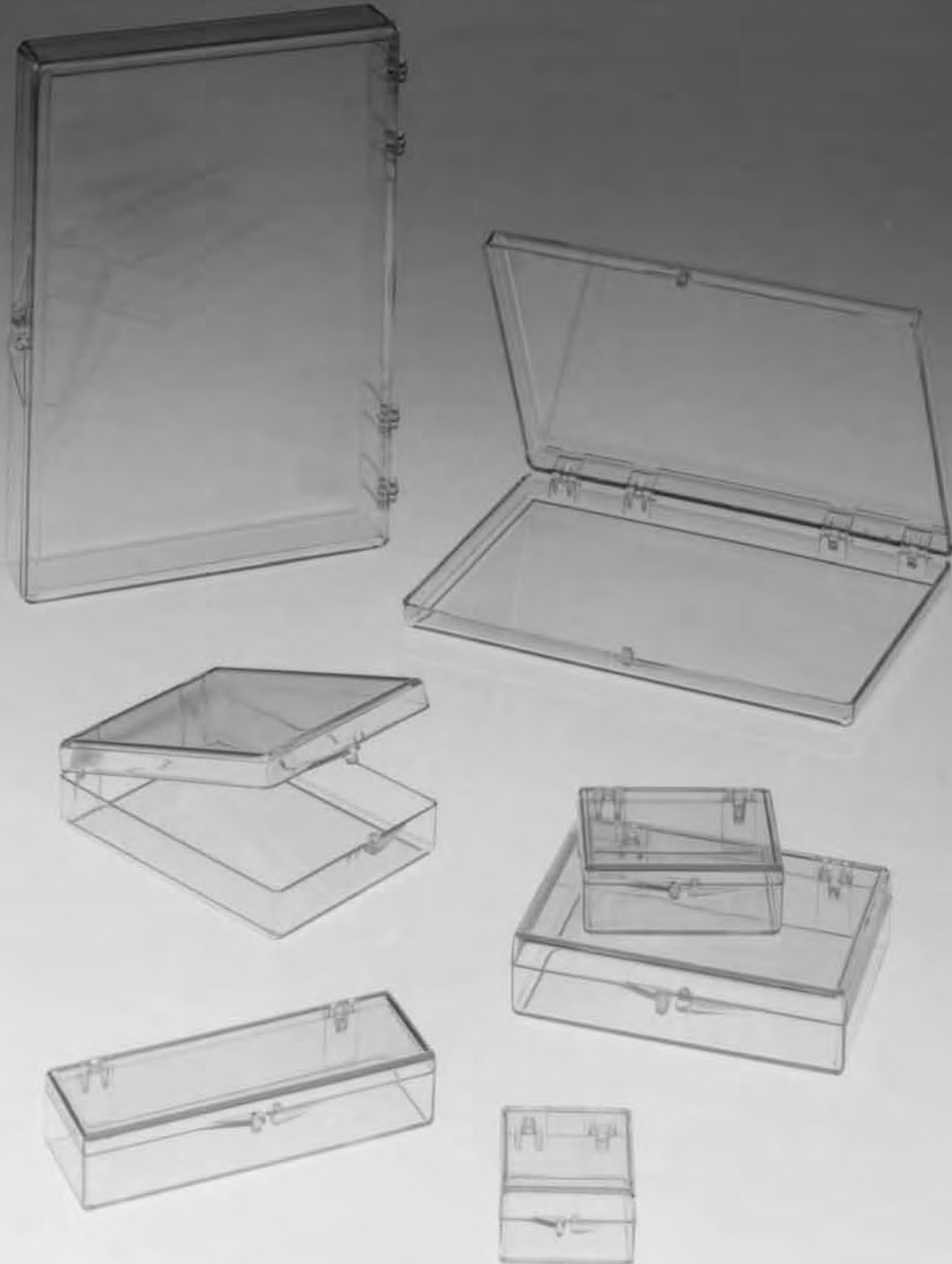

**1" x 1"**

**1 1/4" x 1 1/4"**

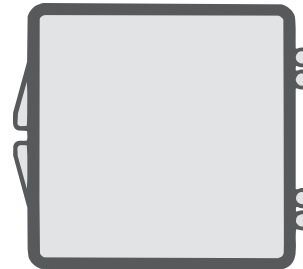

**G10**  
Stockline **1/4"**

**G115**  
Stockline **1/4"**

**G170**  
Stockline **1 1/4"**

**G15**  
Stockline **3/8"**

**G125**  
Stockline **1/2"**

**G175**  
Stockline **1 1/4"**

**G25**  
Stockline **1/2"**

**G135**  
Stockline **5/8"**

**G180**  
Stockline **1 3/8"**

**G35**  
Stockline **5/8"**

**G145**  
Stockline **3/4"**

**G185**  
Stockline **1 5/8"**

**G50**  
Stockline **3/4"**

**G160**  
Stockline **7/8"**

**G75**  
Stockline **1"**

**G165**  
Stockline **1"**

**G190** Lid: 1" Base: 1" = **2"**

# 4 | Stock Hinged Containers

**1<sup>5</sup>/<sub>8</sub>" x 1<sup>5</sup>/<sub>8</sub>"**

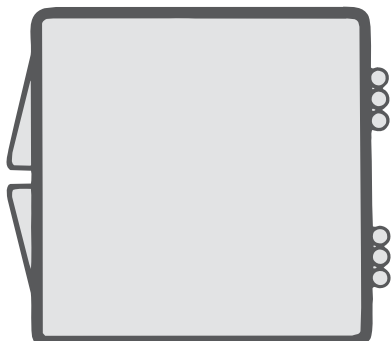

**2" x 1<sup>1</sup>/<sub>8</sub>"**

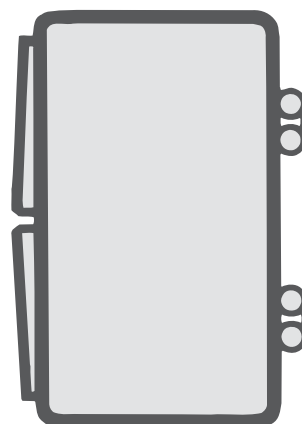

**G196**  
Special Order  
1/4  
1/4  
**1/2"**

**G197**  
Special Order  
1/4  
1/2  
**3/4"**

**G198**  
Special Order  
1/2  
1/2  
**1"**





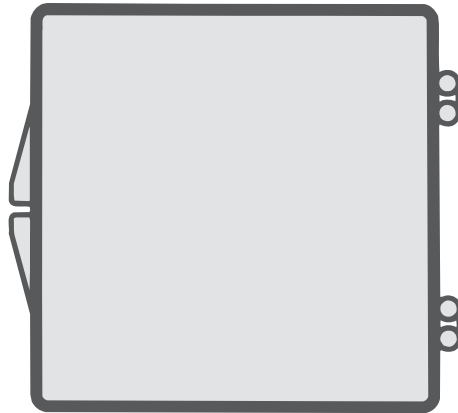

**G230**  
Stockline  
1/8  
1/8  
**1/4"**

**G235**  
Stockline  
1/8  
1/4  
**3/8"**

**G240**  
Stockline  
1/4  
1/4  
**1/2"**

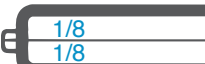
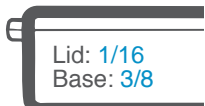
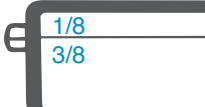
**2" x 2"**

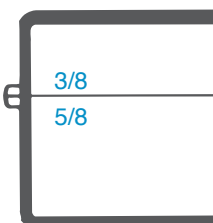
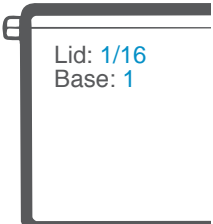
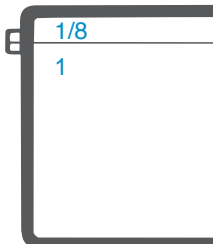
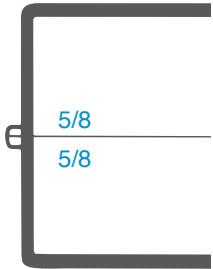

- G601**  **1/8"**  
Lid: 1/16 Base: 1/16
- G602**  **3/16"**  
Lid: 1/16 Base: 1/8
- G600**  **1/4"**  
Stockline Lid: 1/8 Base: 1/8
- G605**  **7/16"**  
Lid: 1/16 Base: 3/8
- G610**  **1/2"**  
Stockline Lid: 1/8 Base: 3/8
- G615**  **11/16"**  
Lid: 1/16 Base: 5/8
- G620**  **3/4"**  
Stockline Lid: 1/8 Base: 5/8
- G630**  **3/4"**  
Lid: 3/8 Base: 3/8

- G640**  **1"**  
Stockline Lid: 3/8 Base: 5/8
- G650**  **1 1/16"**  
Lid: 1/16 Base: 1
- G660**  **1 1/8"**  
Stockline Lid: 1/8 Base: 1
- G670**  **1 1/4"**  
Stockline Lid: 5/8 Base: 5/8

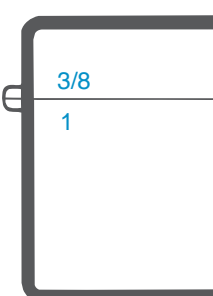
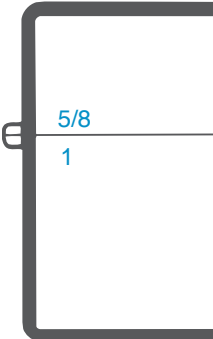
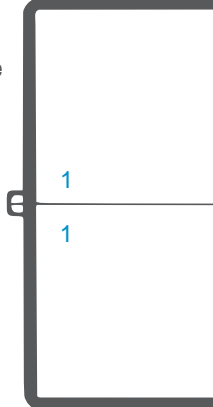
- G675**  **1 3/8"**  
Lid: 3/8 Base: 1
- G685**  **1 5/8"**  
Lid: 5/8 Base: 1
- G690**  **2"**  
Stockline Lid: 1 Base: 1



# 6 Stock Hinged Containers

**2 1/8" x 1 5/8"**

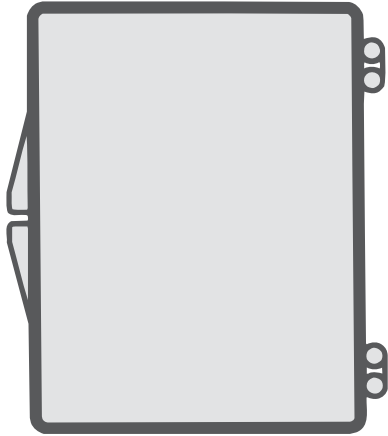

**1 5/8" x 2 1/8"**

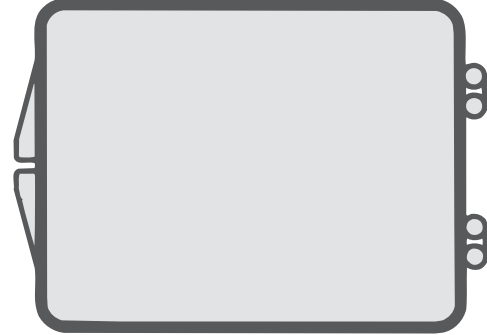

**G300**  
Stockline  **1/4"**

**G305**  
Stockline  **3/8"**

**G310**  
Stockline  **1/2"**

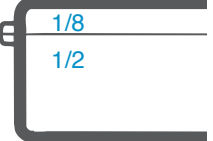
**G315**  
Stockline  **5/8"**

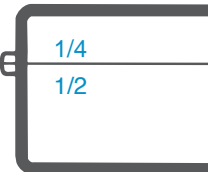
**G320**  
Stockline  **3/4"**

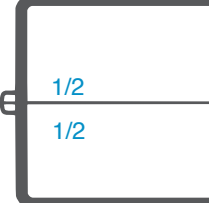
**G325**  
Stockline  **1"**

**G250**  
Stockline  **3/8"**

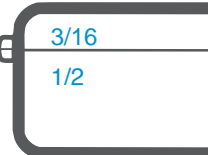
**G369**  
Stockline  **11/16"**

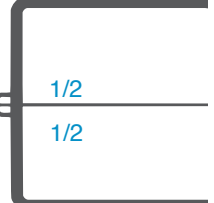
**G684**  
Stockline  **1"**

**2<sup>3</sup>/<sub>32</sub>" x 3"**

**2<sup>9</sup>/<sub>16</sub>" x 2<sup>9</sup>/<sub>16</sub>"**

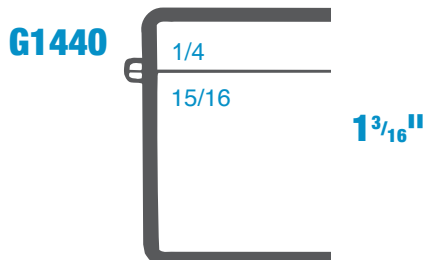
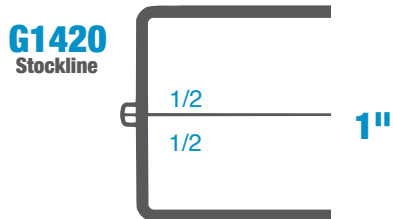
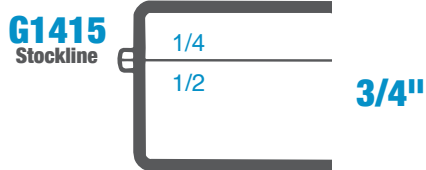
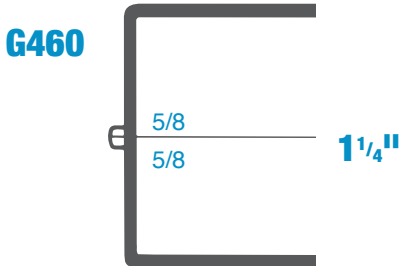
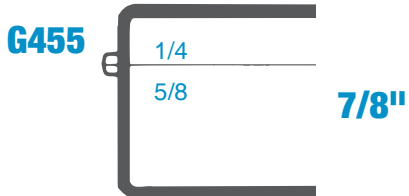
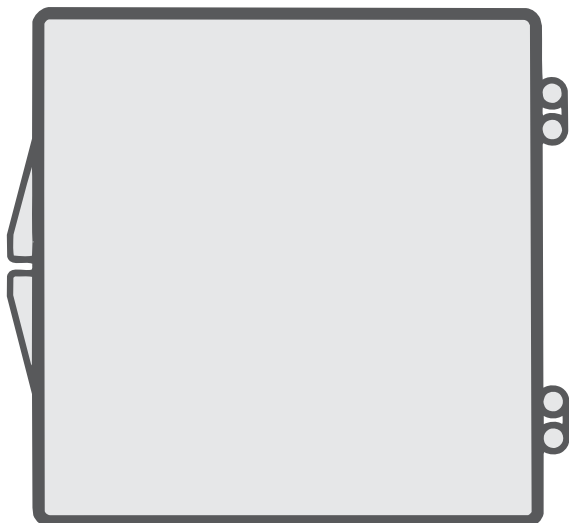
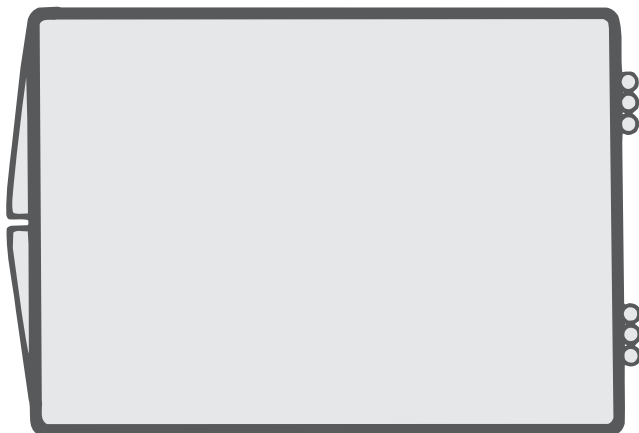

Continued next page

# 8 Stock Hinged Containers

**2<sup>9</sup>/<sub>16</sub>" x 2<sup>9</sup>/<sub>16</sub>"** Continued

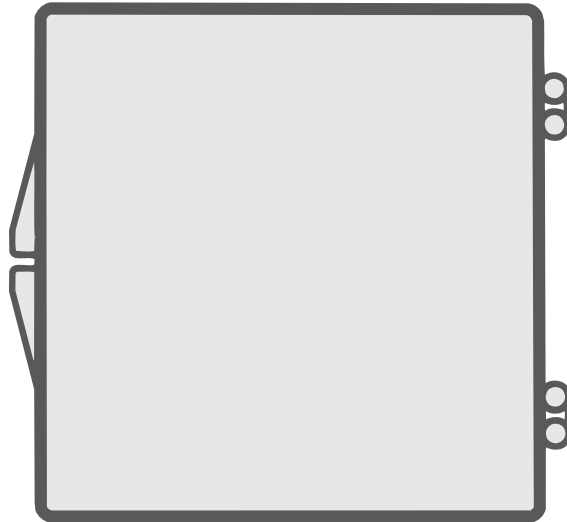

Continued from previous page

**G1443**  
Stockline

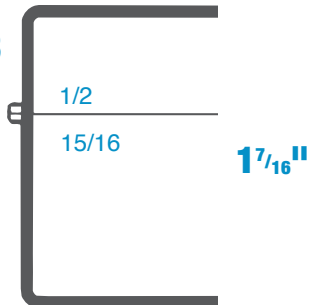

**G1466**

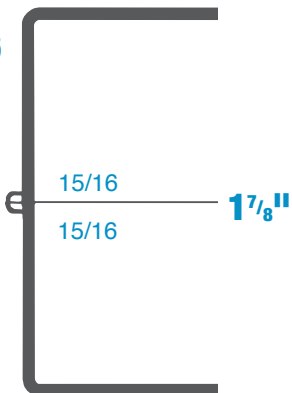

**G1480**  
Stockline

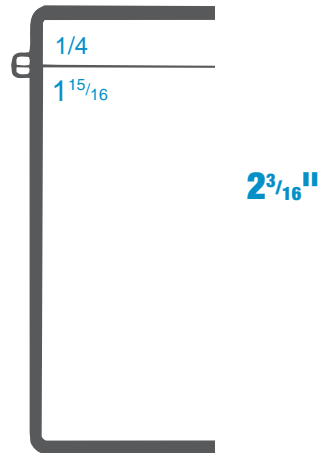

**G1485**

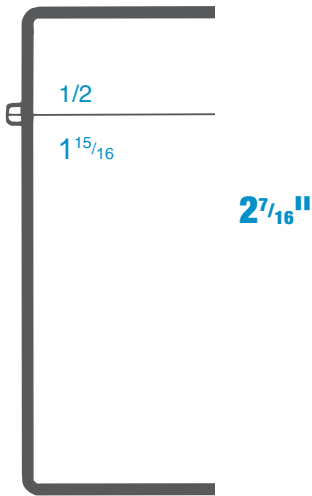

**G1490**

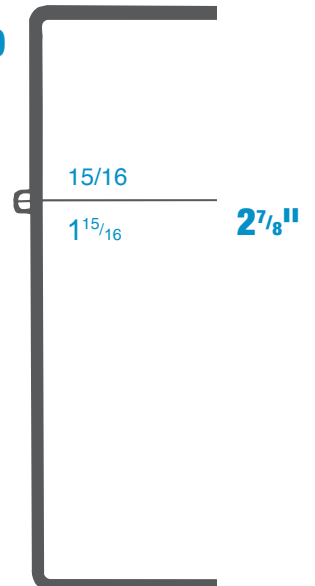

**G1497** Lid: 1<sup>15</sup>/<sub>16</sub>" Base: 1<sup>15</sup>/<sub>16</sub>" = **3<sup>7</sup>/<sub>8</sub>"**

**2<sup>5</sup>/<sub>8</sub>" x 2<sup>13</sup>/<sub>16</sub>"**

**2<sup>27</sup>/<sub>32</sub>" x 1<sup>7</sup>/<sub>16</sub>"**

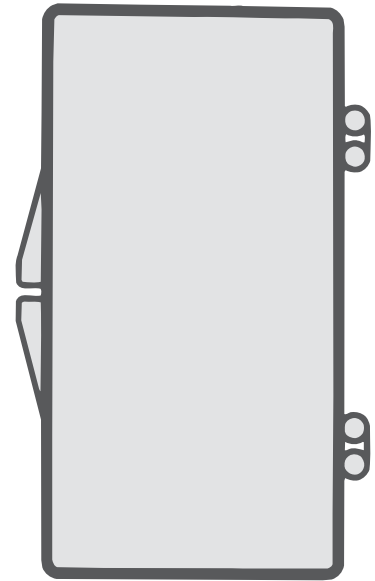

**G268**  
Special Order  
5/32  
5/32  
**5/16"**

**G543**  
Special Order  
21/64  
21/64  
**21/32"**

# 10 | Stock Hinged Containers

**2<sup>7</sup>/<sub>8</sub>" x 1<sup>3</sup>/<sub>16</sub>"**

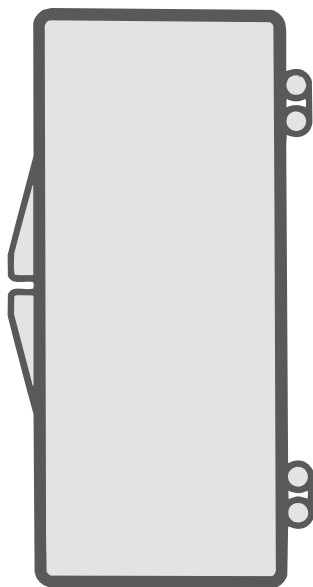

**G525**  
Stockline  
1/8  
1/8  
**1/4"**

**G535**  
Stockline  
1/8  
1/4  
**3/8"**

**G540**  
Stockline  
1/4  
1/4  
**1/2"**

**G550**  
Stockline  
1/8  
1/2  
**5/8"**

**G560**  
Stockline  
1/4  
1/2  
**3/4"**

**G565**  
1/8  
5/8  
**3/4"**

**G570**  
1/4  
5/8  
**7/8"**





**G575**  
Stockline  
1/2  
1/2  
**1"**

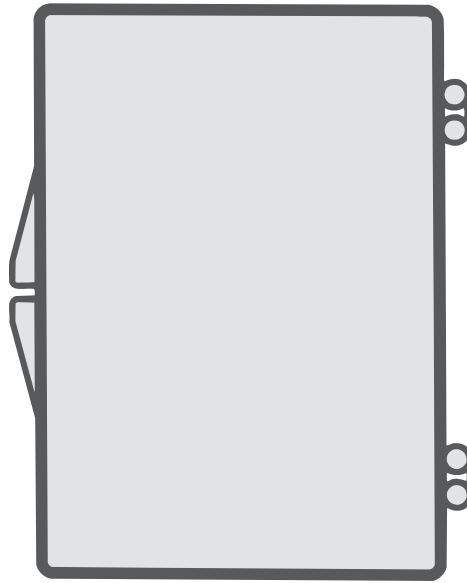

**G580**  
1/2  
5/8  
**1<sup>1</sup>/<sub>8</sub>"**



**G585**  
5/8  
5/8  
**1<sup>1</sup>/<sub>4</sub>"**

**2<sup>7</sup>/<sub>8</sub>" x 2"**

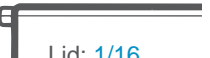

- G725**  **1/8"**  
Lid: 1/16 Base: 1/16
- G760**  **1/4"**  
Lid: 1/16 Base: 3/16
- G765**  **5/16"**  
Lid: 1/16 Base: 1/4
- G770**  **3/8"**  
3/16  
3/16
- G790**  **1/2"**  
1/4  
1/4

- G785**  **7/16"**  
3/16  
1/4
- G700**  **9/16"**  
Lid: 1/16  
Base: 1/2
- G775**  **11/16"**  
3/16  
1/2
- G780**  **3/4"**  
1/4  
1/2

- G750**  **1"**  
Stockline  
1/2  
1/2
- G710**  **1<sup>1</sup>/<sub>16</sub>"**  
Stockline  
Lid: 1/16  
Base: 1
- G755**  **1<sup>1</sup>/<sub>8</sub>"**  
1/8  
1

Continued next page

# 12 Stock Hinged Containers

**2<sup>7</sup>/<sub>8</sub>" x 2"** Continued

**2<sup>15</sup>/<sub>16</sub>" x 1<sup>5</sup>/<sub>16</sub>"**

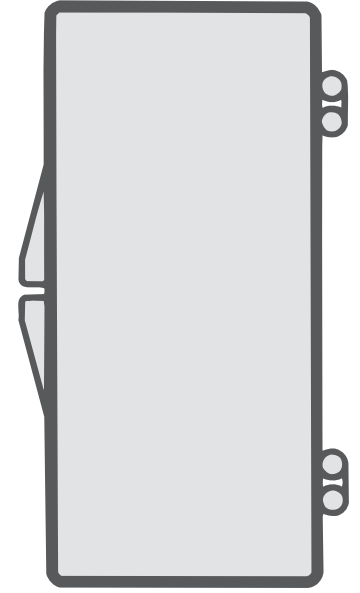
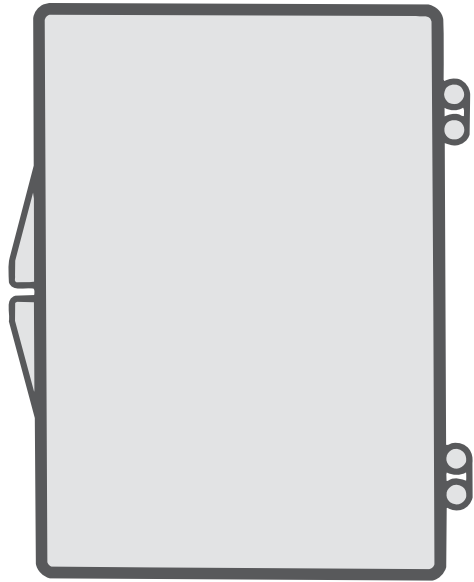

Continued from previous page

**G715**  
Stockline

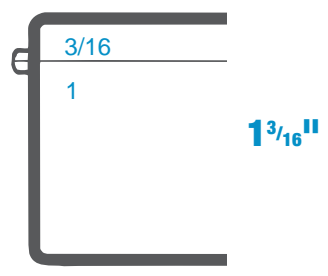

**G705**  
Stockline

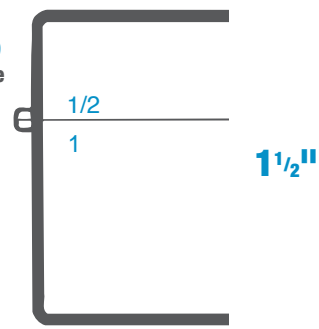

**G720**  
Stockline

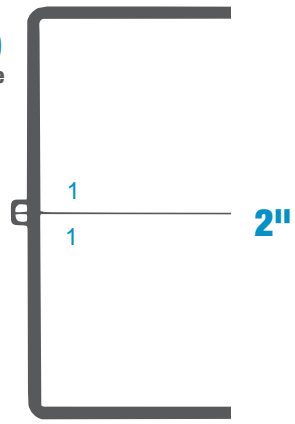

**G280**



**G285**

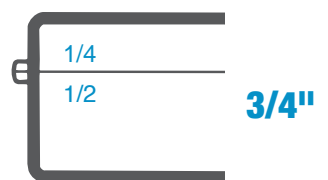

**G290**

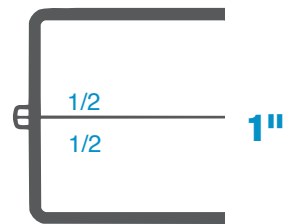

**3" x 3"**

**3 1/16" x 3 1/16"**

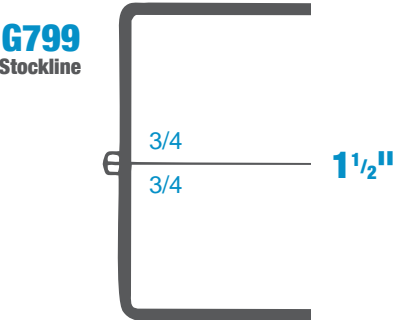
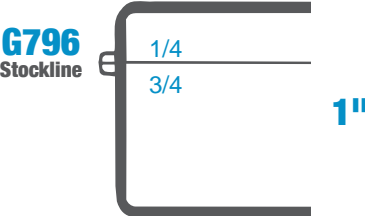
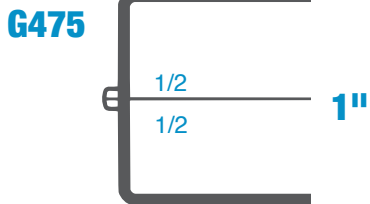
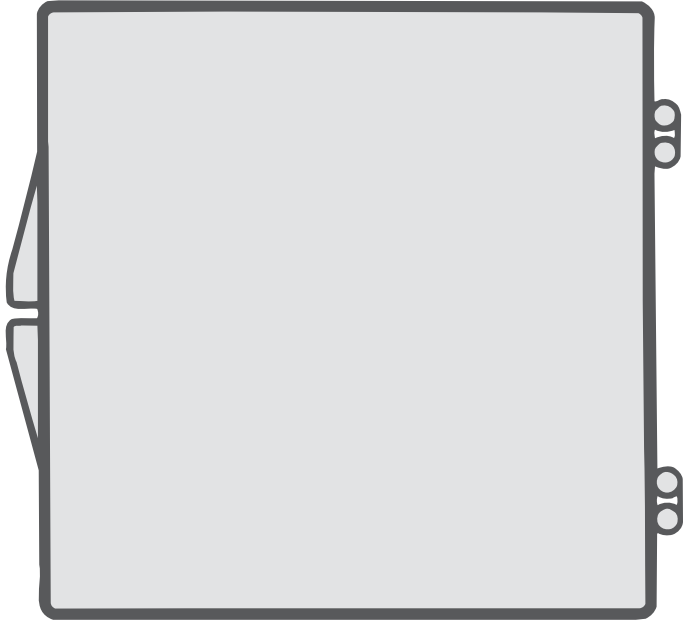
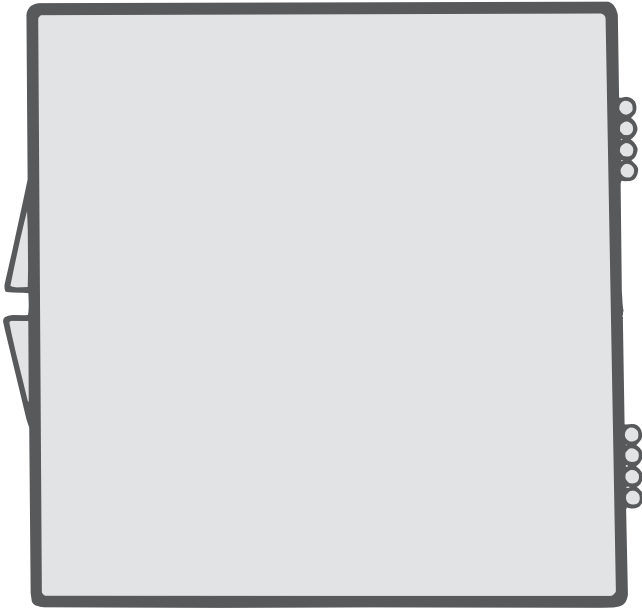



# 14 | Stock Hinged Containers

**$3\frac{5}{16}'' \times 3''$**

**$3\frac{3}{8}'' \times 2\frac{1}{2}''$**

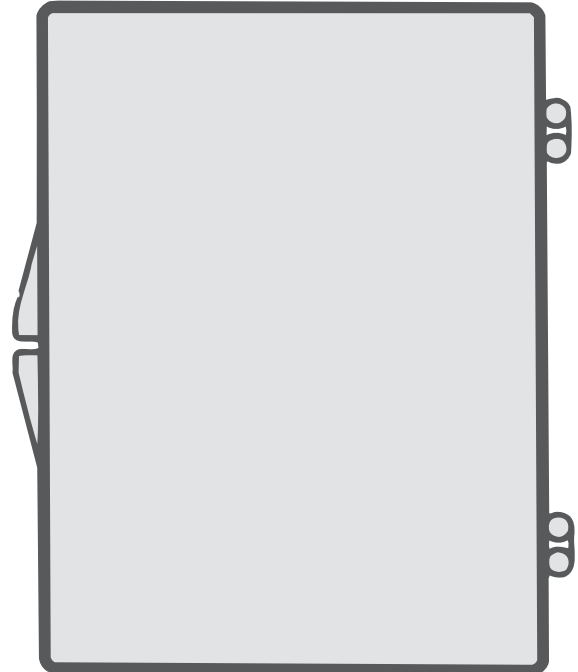
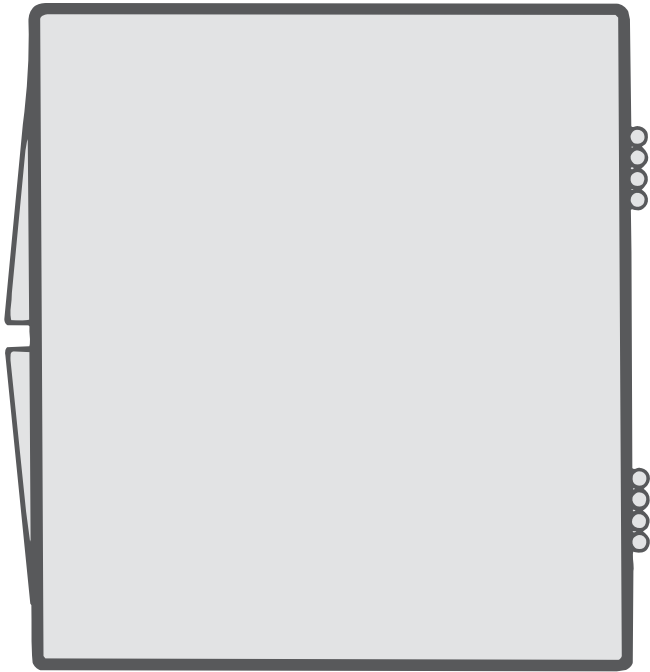

**G485**  
Special Order

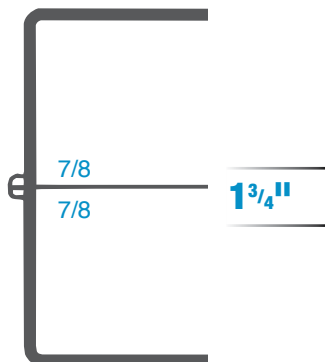

**G895**

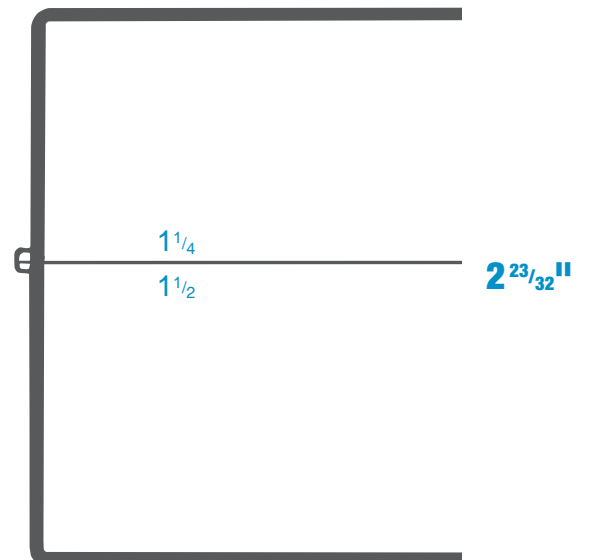

**3 1/2" x 11/16"**                      **3 1/2" x 2 1/8"**

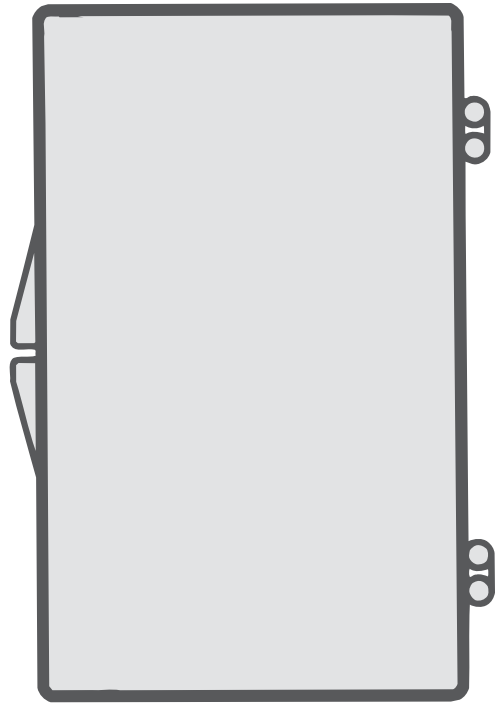
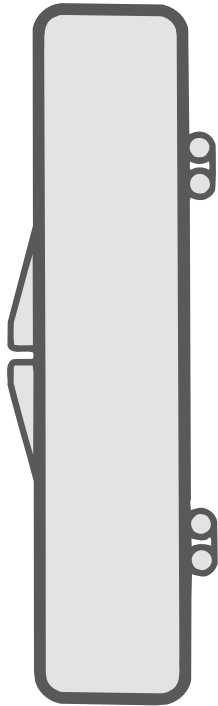

**G410** **1/4"**

**G415** **3/8"**

**G425**  
Stockline **1/2"**

**G910** **1/4"**

**G915** **5/16"**

**G916** **5/16"**

**G920** **3/8"**

# 16 Stock Hinged Containers

3 1/2" x 2 9/16"

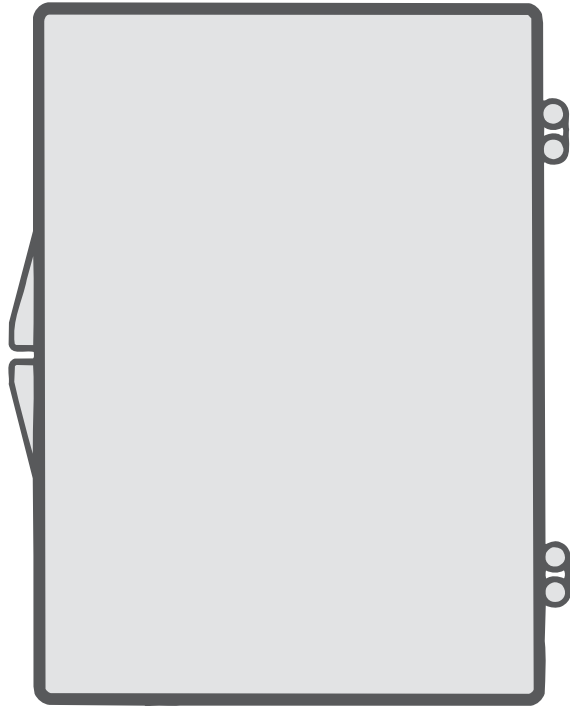

**G802**  
Stockline

1/8	1/8	1/4"
-----	-----	------

**G805**  
Stockline

1/8	1/4	3/8"
-----	-----	------

**G803**  
Stockline

1/4	1/4	1/2"
-----	-----	------

**G825**  
Stockline

1/8	1/2	5/8"
-----	-----	------

**G846**  
Stockline

1/4	1/2	3/4"
-----	-----	------

**G871**  
Stockline

1/8	7/8	1"
-----	-----	----

**G848**  
Stockline

1/2	1/2	1"
-----	-----	----

**G872**  
Stockline

1/4	7/8	1 1/8"
-----	-----	--------

**G873**  
Stockline

1/2	7/8	1 3/8"
-----	-----	--------

Continued **3 1/2" x 2 9/16"**

**G874**  
Stockline

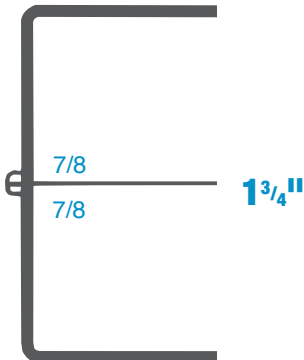

**G875**  
Stockline

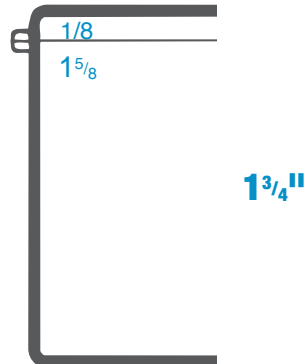

**G876**  
Stockline

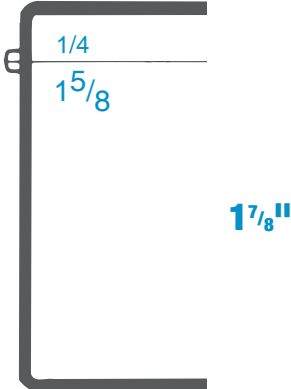

**G877**  
Stockline

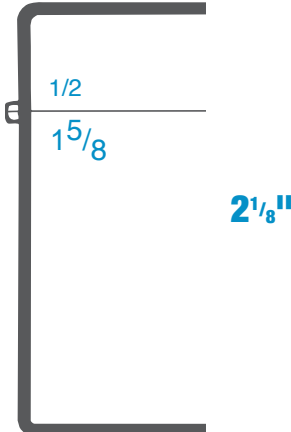

**G878**  
Stockline

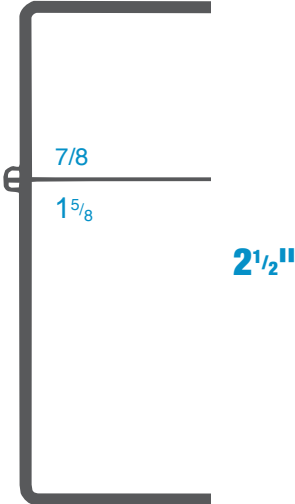

**G879**  
Stockline

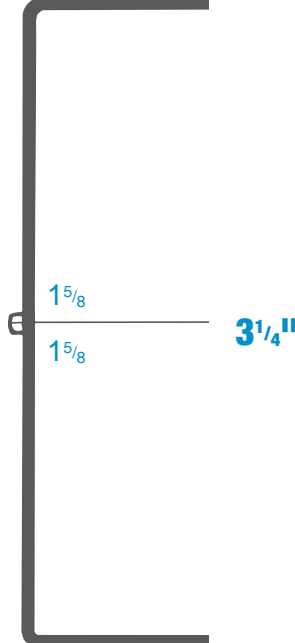

# 18 Stock Hinged Containers

**2<sup>9</sup>/<sub>16</sub>" x 3<sup>1</sup>/<sub>2</sub>"**

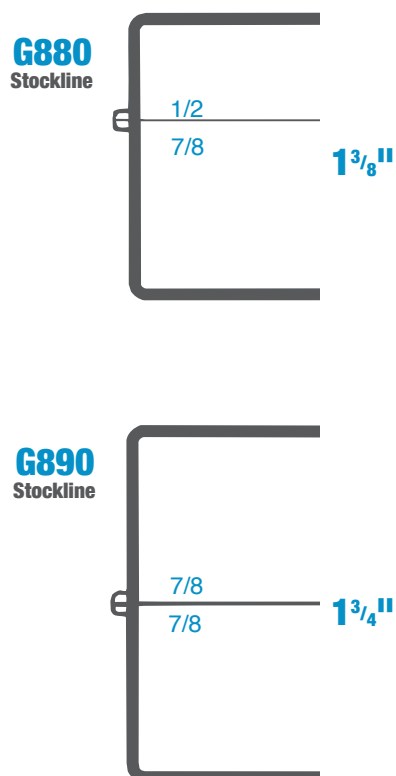
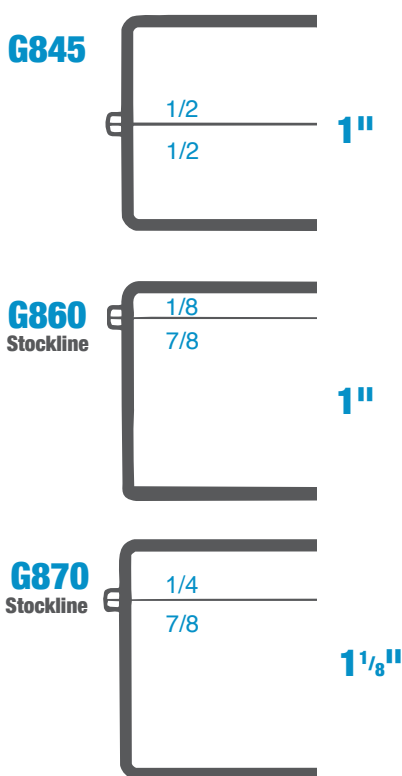
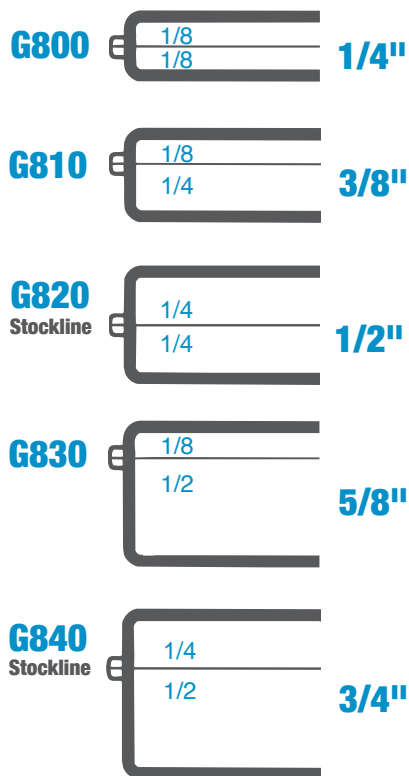

**3<sup>3</sup>/<sub>4</sub>" x 1<sup>3</sup>/<sub>16</sub>"**

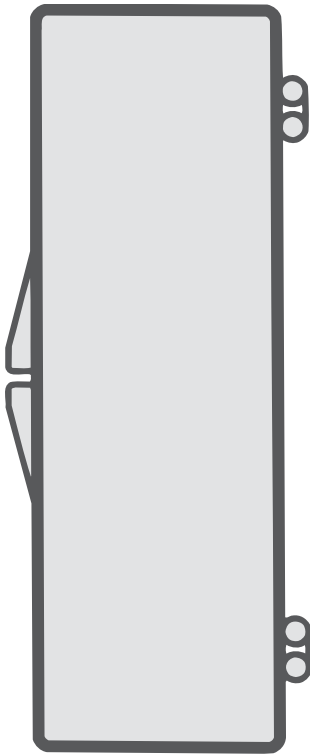

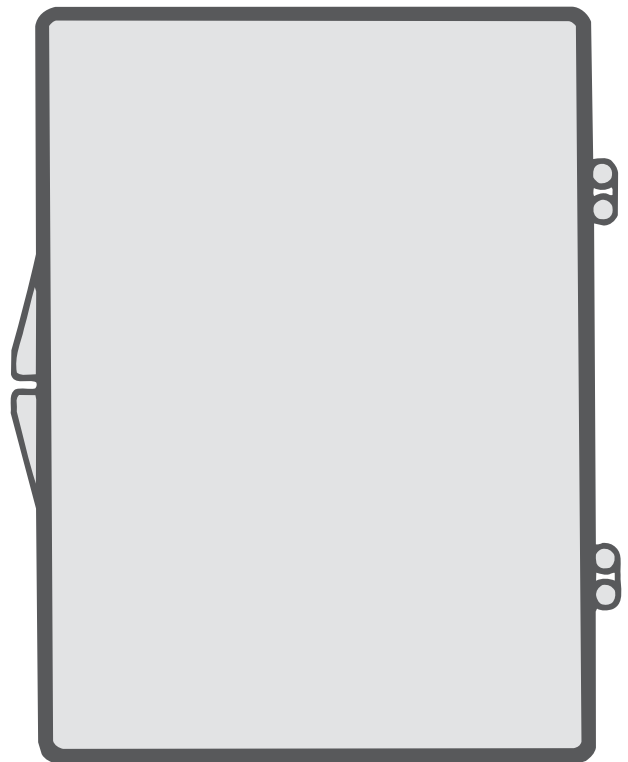

**3<sup>3</sup>/<sub>4</sub>" x 2<sup>3</sup>/<sub>4</sub>"**

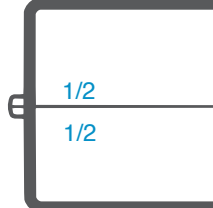

**G900**  
Stockline  **1/4"**

**G930**  
Stockline  **5/8"**

**G950**  
Stockline  **1"**

**G850**  
Special Order  **1/4"**

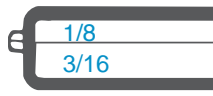
**G852**  
Special Order  **5/16"**

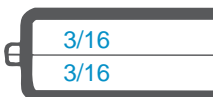
**G855**  
Special Order  **3/8"**

# 20 Stock Hinged Containers

**3 7/8" x 1 15/16"**

**4" x 1 5/8"**

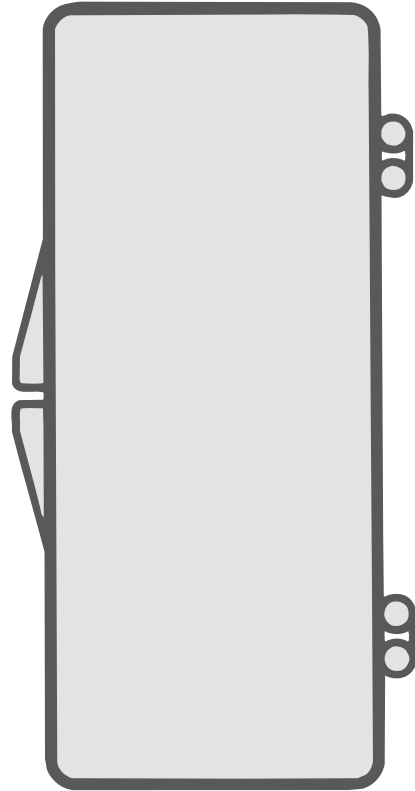
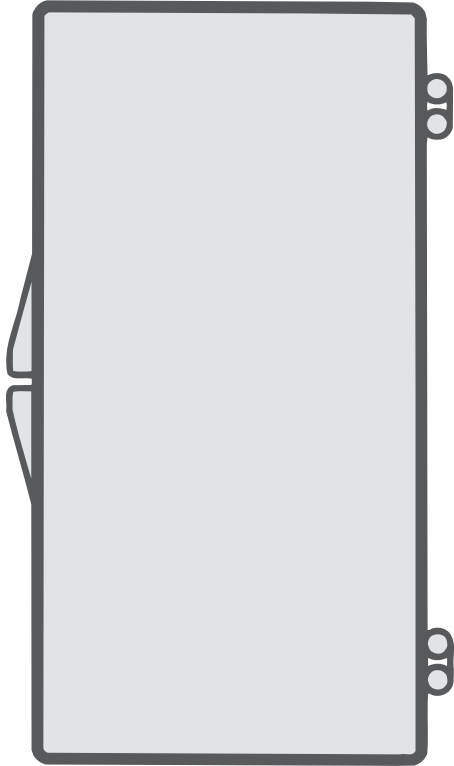

**G975**



**G990**  
Special  
Order

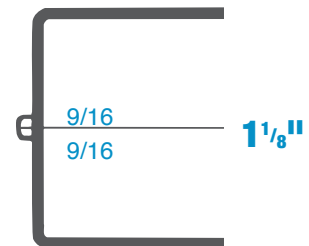

**4 1/2" x 1 3/4"**

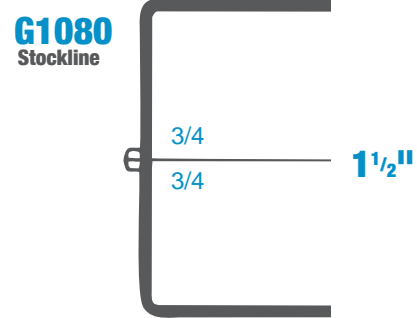
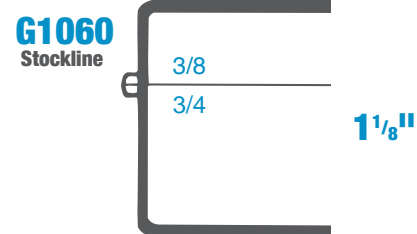
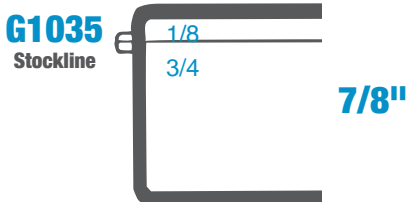
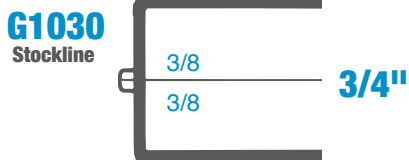
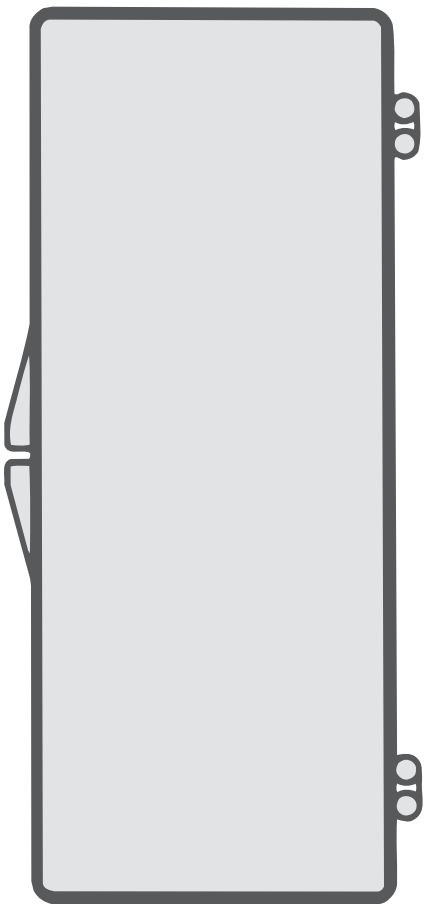



# 22 Stock Hinged Containers

**4<sup>3</sup>/<sub>8</sub>" x 2<sup>1</sup>/<sub>16</sub>"**

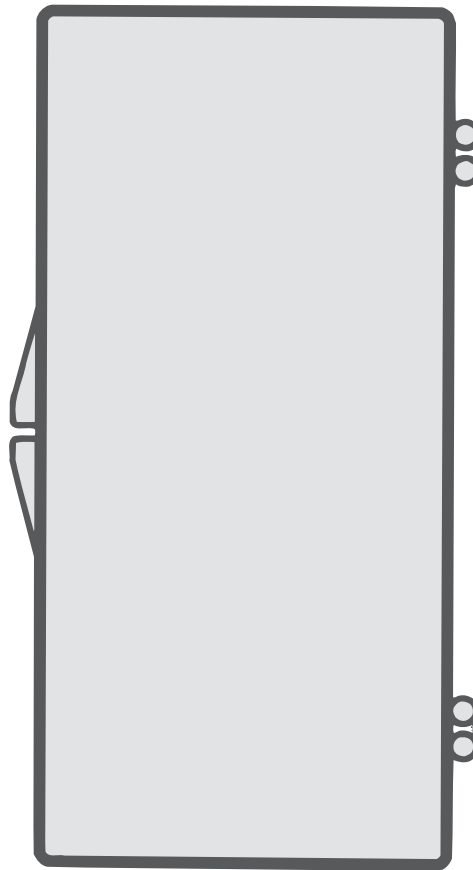

**G1105**  
Stockline  
7/32  
7/32  
**7/16"**

**G1110**  
Stockline  
7/32  
9/16  
**25/32"**

**G1115**  
Stockline  
9/16  
9/16  
**1<sup>1</sup>/<sub>8</sub>"**

**G1112**  
Special Order  
7/32  
1<sup>7</sup>/<sub>32</sub>  
**1<sup>7</sup>/<sub>16</sub>"**

**G1118**  
Special Order  
9/16  
1<sup>7</sup>/<sub>32</sub>  
**1<sup>25</sup>/<sub>32</sub>"**

**G1120**  
Special Order  
1<sup>7</sup>/<sub>32</sub>  
1<sup>7</sup>/<sub>32</sub>  
**2<sup>7</sup>/<sub>16</sub>"**

**4<sup>3</sup>/<sub>8</sub>" x 2<sup>1</sup>/<sub>16</sub>"** **4<sup>5</sup>/<sub>8</sub>" x 2<sup>7</sup>/<sub>8</sub>"**

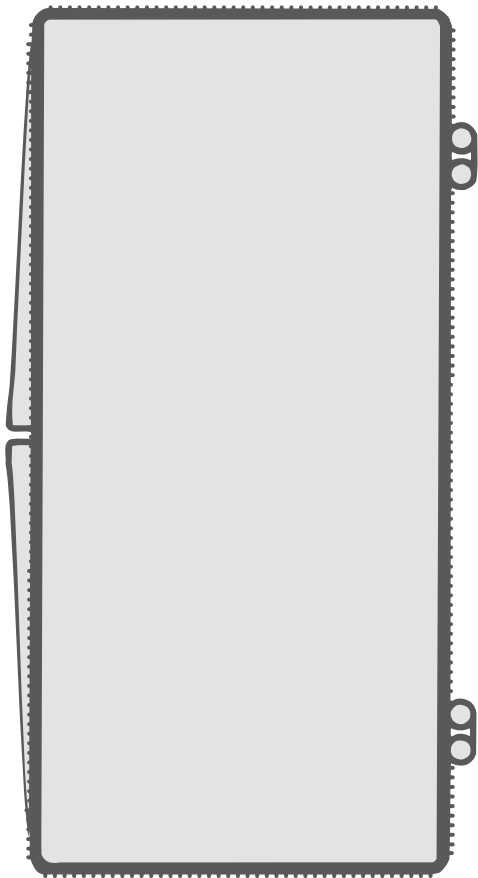

with ridged side walls

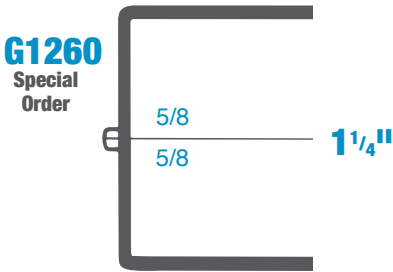
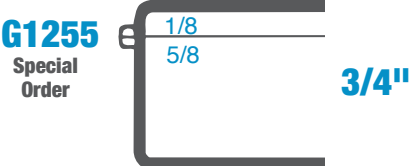
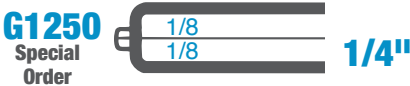
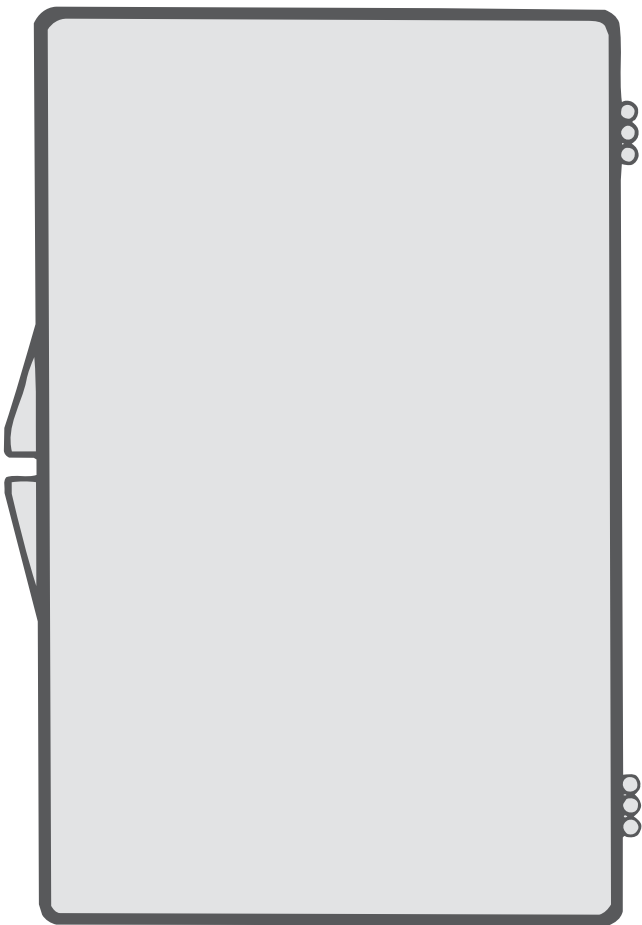

# 24 | Stock Hinged Containers

**4<sup>1</sup>/<sub>16</sub>" x 4<sup>1</sup>/<sub>16</sub>"**

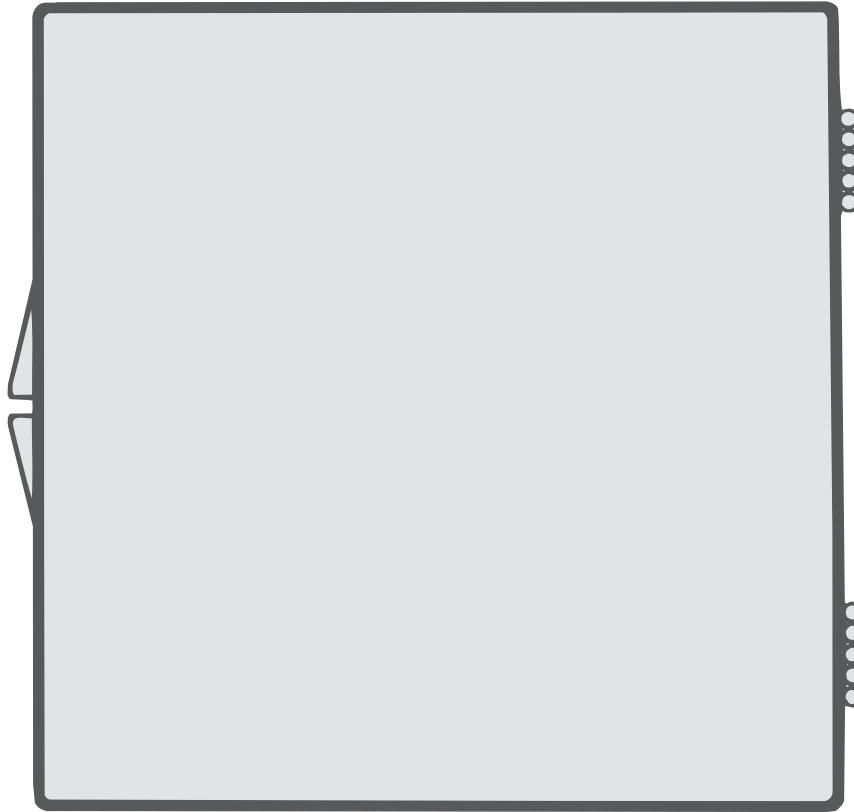

**G1580**

3/16
3/16

**3/8"**

**G1585**

3/16
5/16

**1/2"**

**G1590**

5/16
5/16

**5/8"**

**4<sup>9</sup>/<sub>16</sub>" X 4<sup>9</sup>/<sub>16</sub>"**

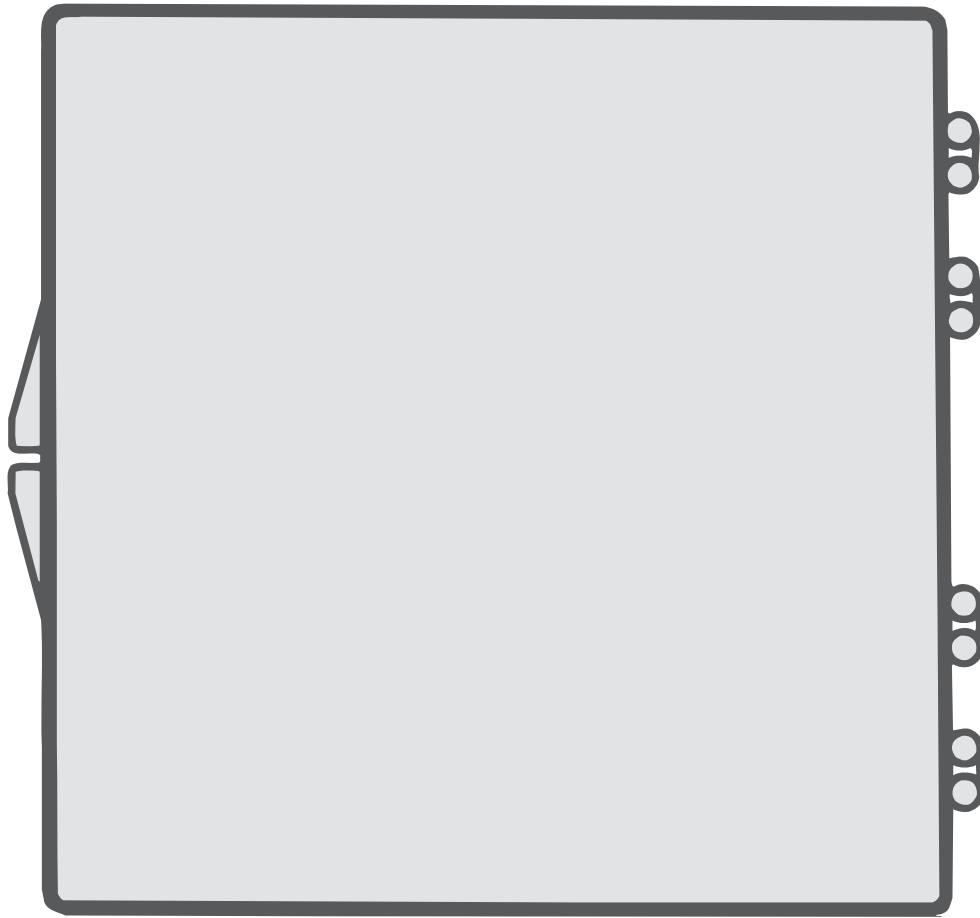

**with four hinges**

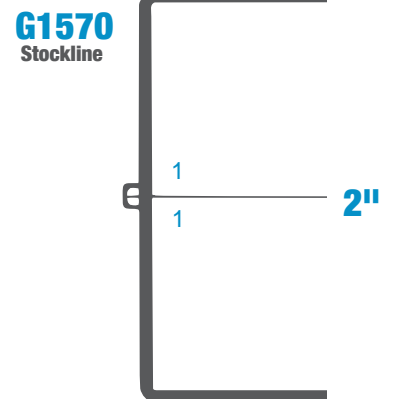
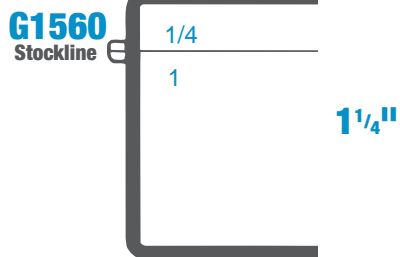

# 26 Stock Hinged Containers

4<sup>5</sup>/<sub>8</sub>" x 3<sup>1</sup>/<sub>2</sub>"

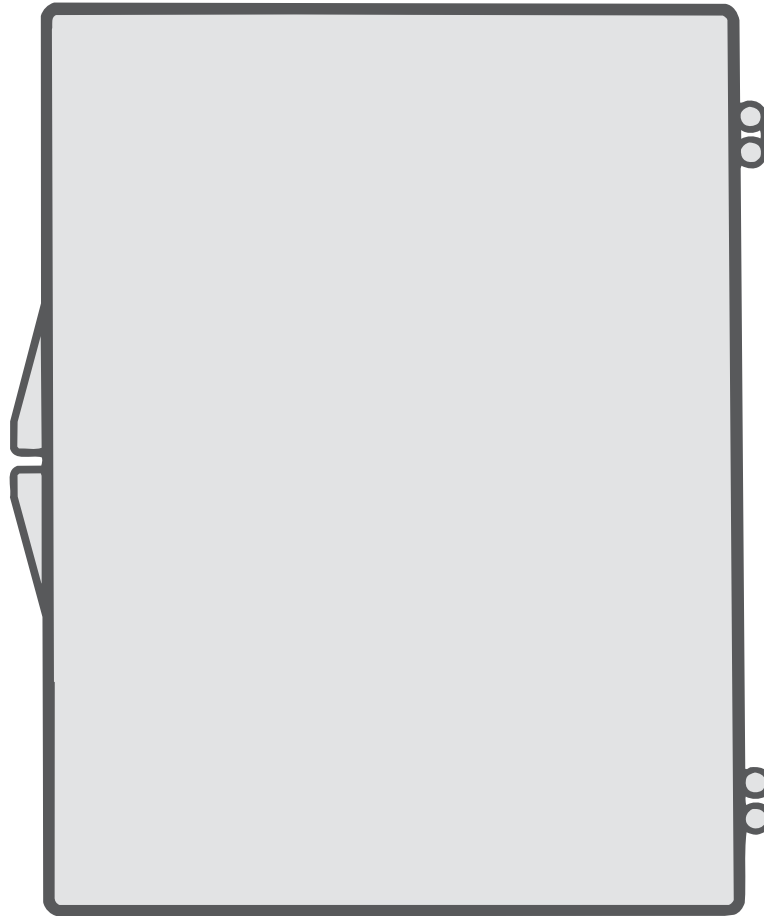

**G1125**  
Stockline 1/8  
1/8 **1/4"**

**G1130**  
Stockline 1/8  
1/4 **3/8"**

**G1135**  
Stockline 1/4  
1/4 **1/2"**

**G1150**  
Stockline 1/8  
5/8 **3/4"**

**G1155**  
Stockline 1/4  
5/8 **7/8"**

**G1165**  
Stockline 1/8  
7/8 **1"**

**G1170**  
Stockline 1/4  
7/8 **1<sup>1</sup>/<sub>8</sub>"**

**G1185**  
Stockline 5/8  
7/8 **1<sup>1</sup>/<sub>2</sub>"**

**G1175**  
Stockline 5/8  
5/8 **1<sup>1</sup>/<sub>4</sub>"**

**G1190**  
Stockline 7/8  
7/8 **1<sup>3</sup>/<sub>4</sub>"**

**5<sup>1/16</sup>" x 3<sup>7/8</sup>"**

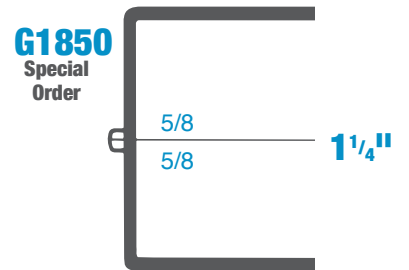
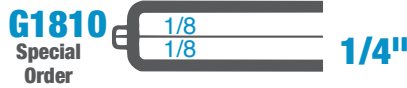
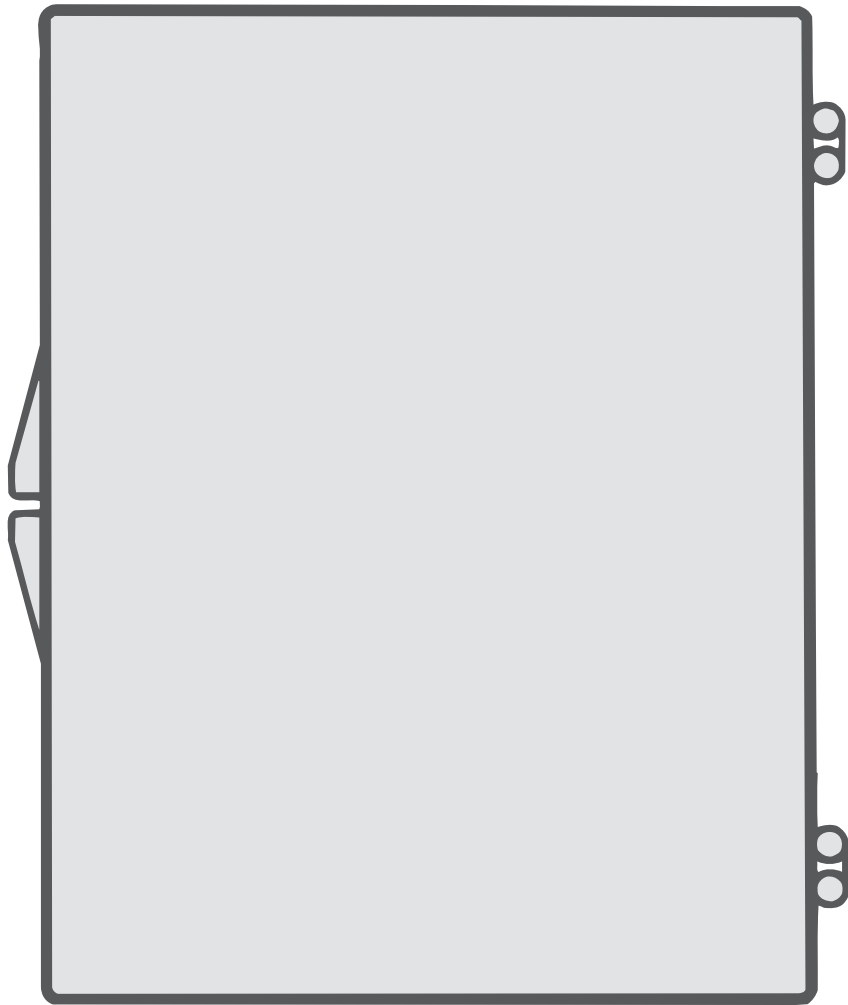

# 28 Stock Hinged Containers

5 1/8" x 3 1/8"

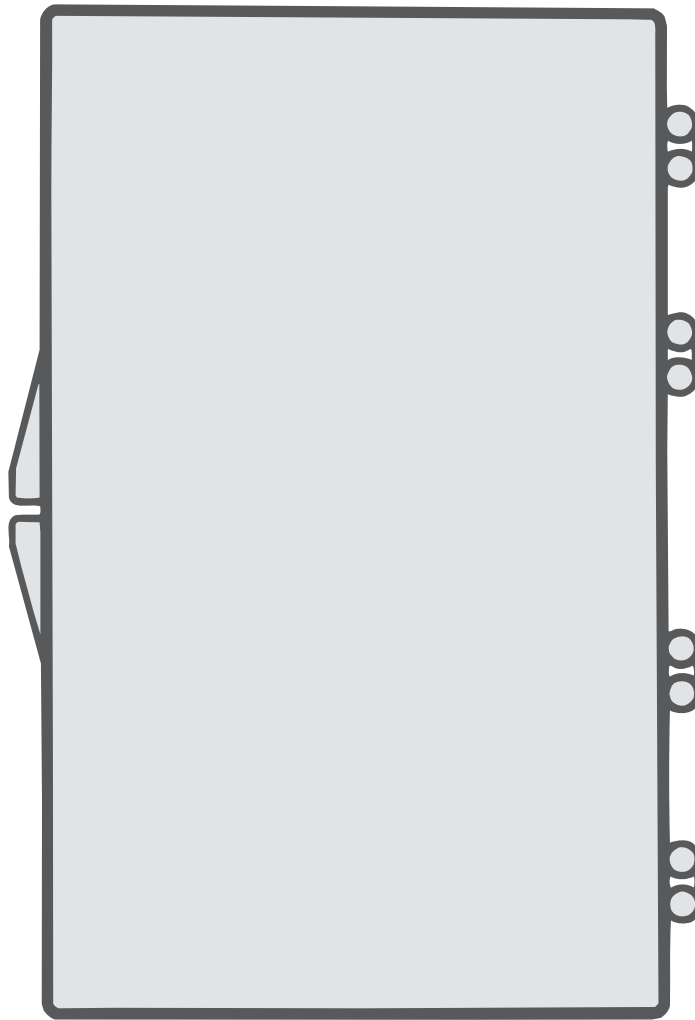

**G1800**  
Stockline

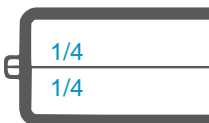

1/2"

**G1815**  
Stockline

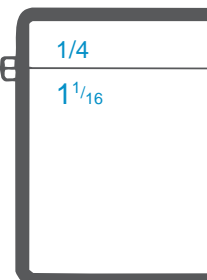

1 5/16"

**G1820**

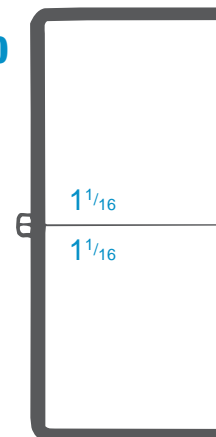

2 1/8"

Continued **5<sup>1</sup>/<sub>8</sub>" x 3<sup>1</sup>/<sub>8</sub>"**

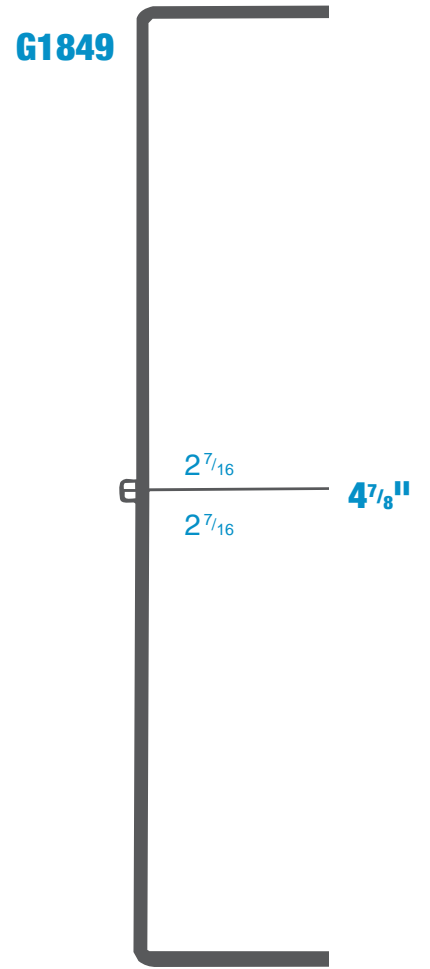
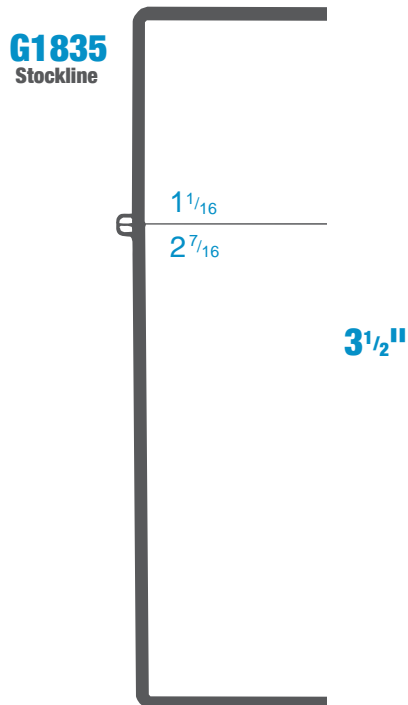
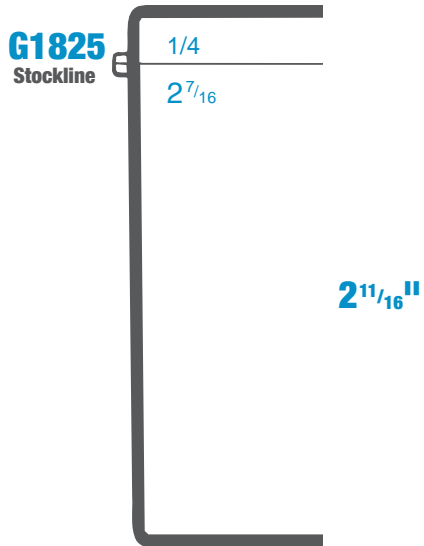



# 30 Stock Hinged Containers

5 1/4" x 2 1/4"

5 7/16" x 2 1/4"

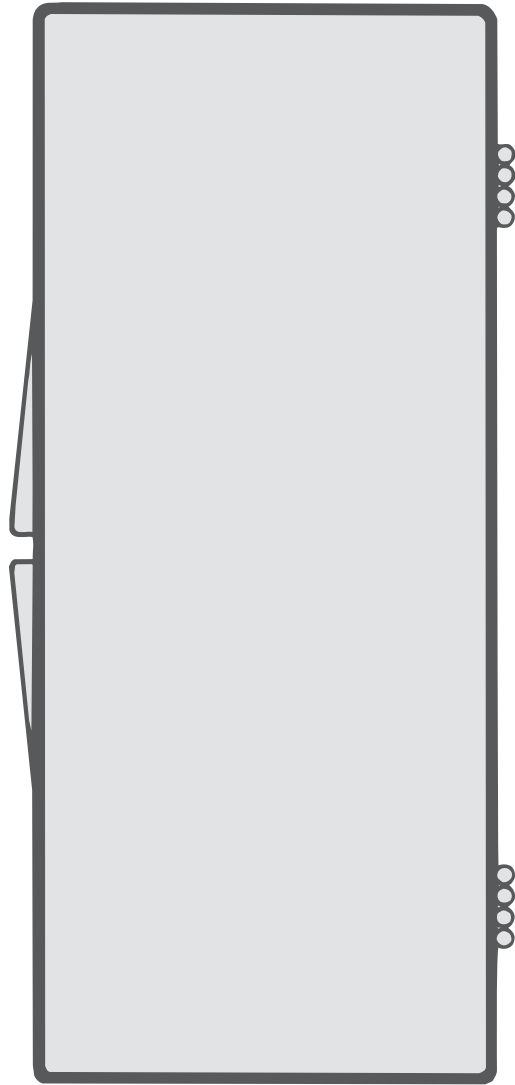
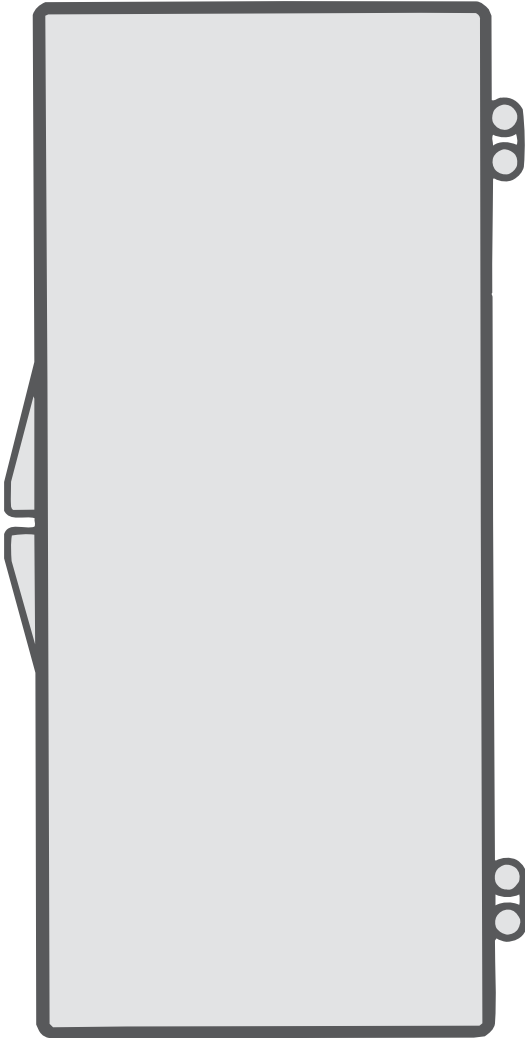

**G1198**

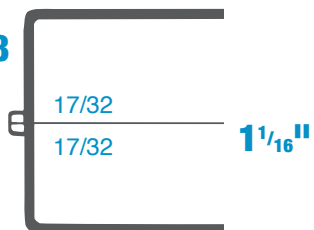

**G1640**  
Special Order

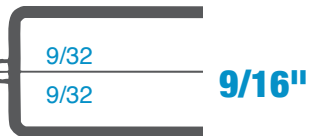

**G1645**  
Special Order

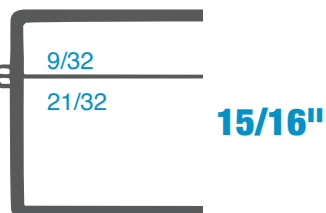

**G1650**  
Special Order

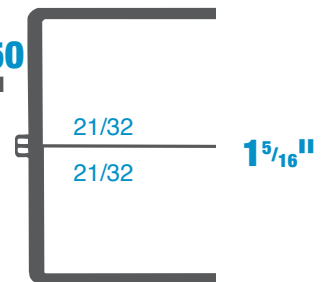

**5 1/2" x 1 3/4"**

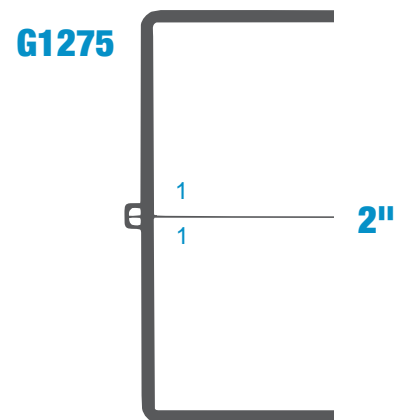
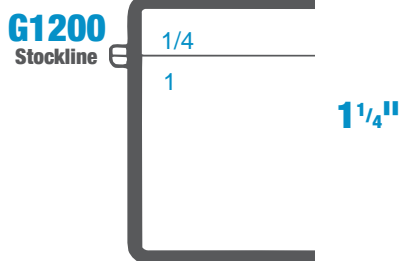
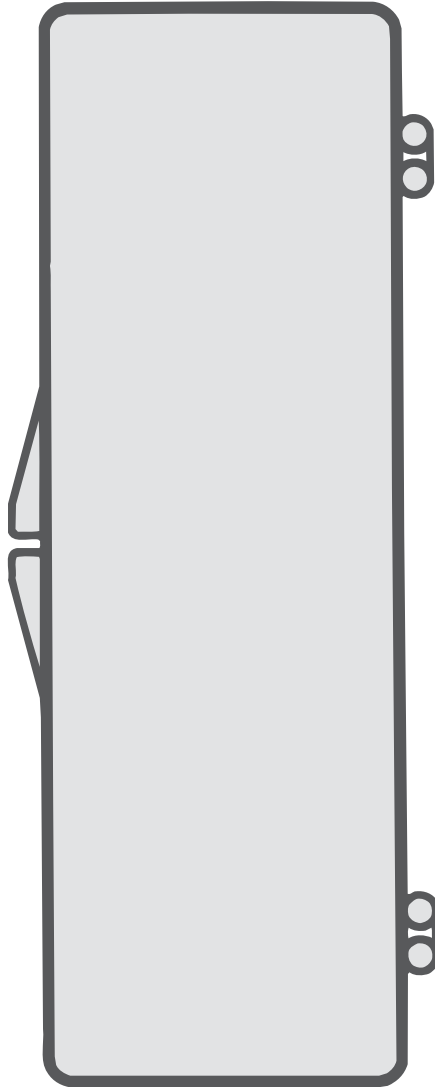

# 32 Stock Hinged Containers

**5<sup>5</sup>/<sub>8</sub>" x 9<sup>9</sup>/<sub>16</sub>"**

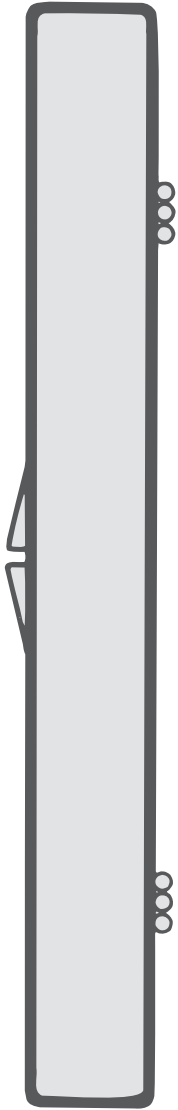

**G1660**  
Special Order

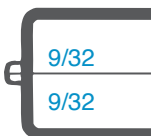

**9/16"**

**5<sup>3</sup>/<sub>4</sub>" x 1<sup>1</sup>/<sub>2</sub>"**

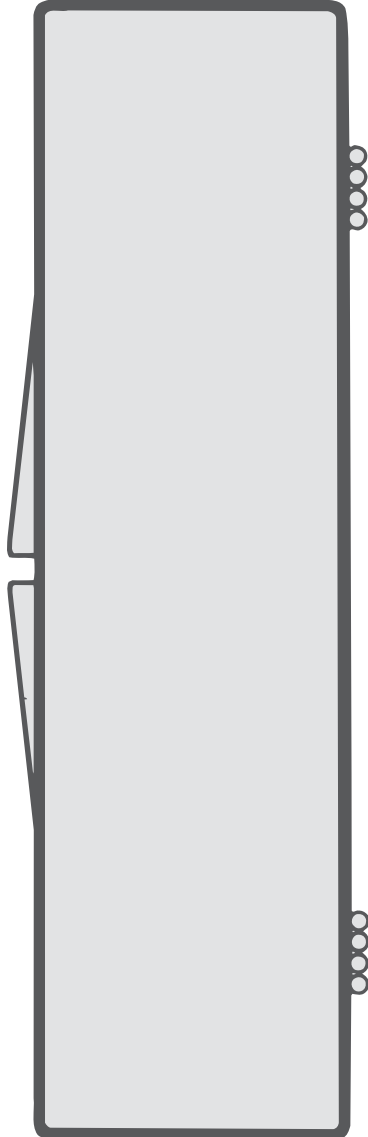

**G1670**  
Special Order



**23/32"**

**5<sup>13/16</sup>" x 1<sup>15/16</sup>"** **6" x 2<sup>1/4</sup>"**

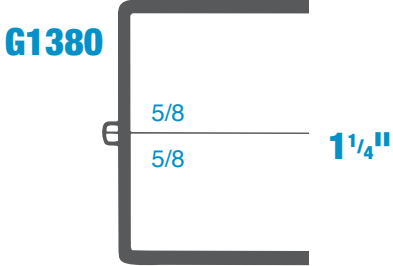
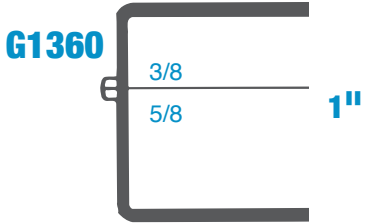
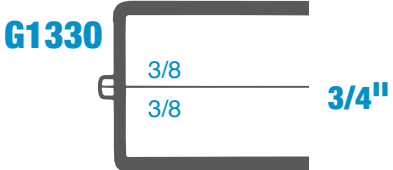
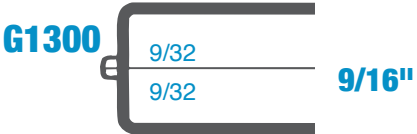
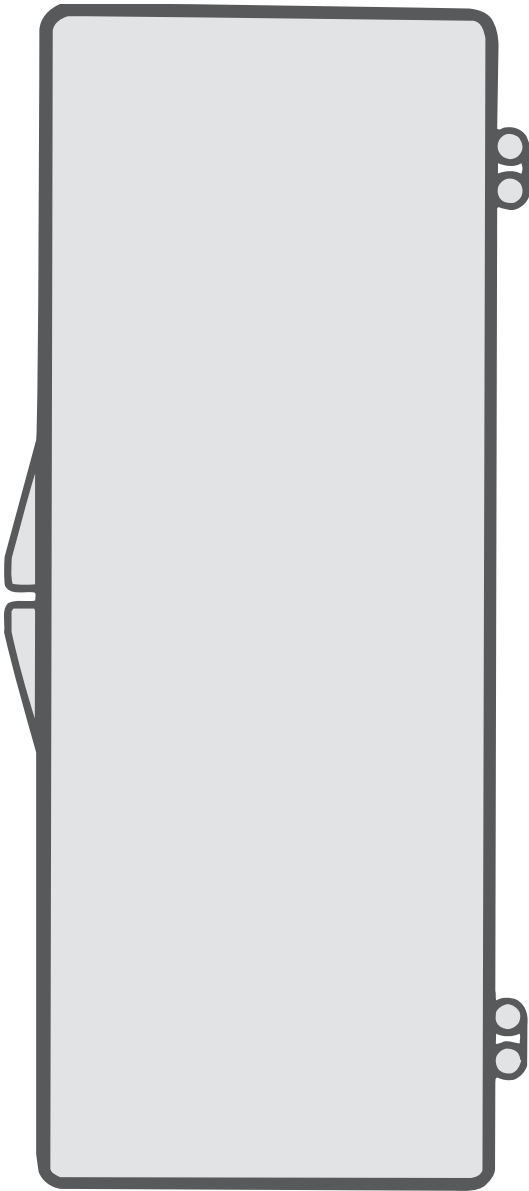
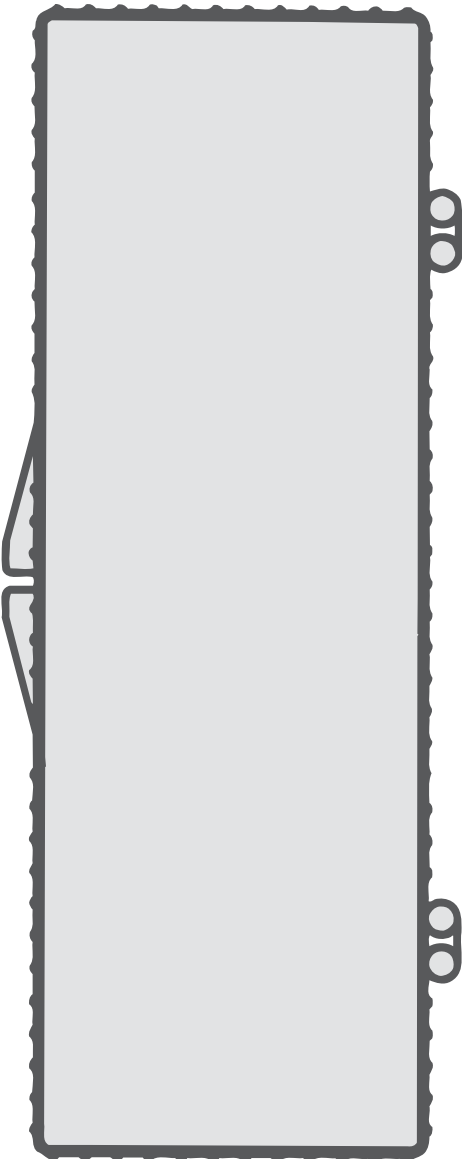

# 34 | Stock Hinged Containers

6" x 4"

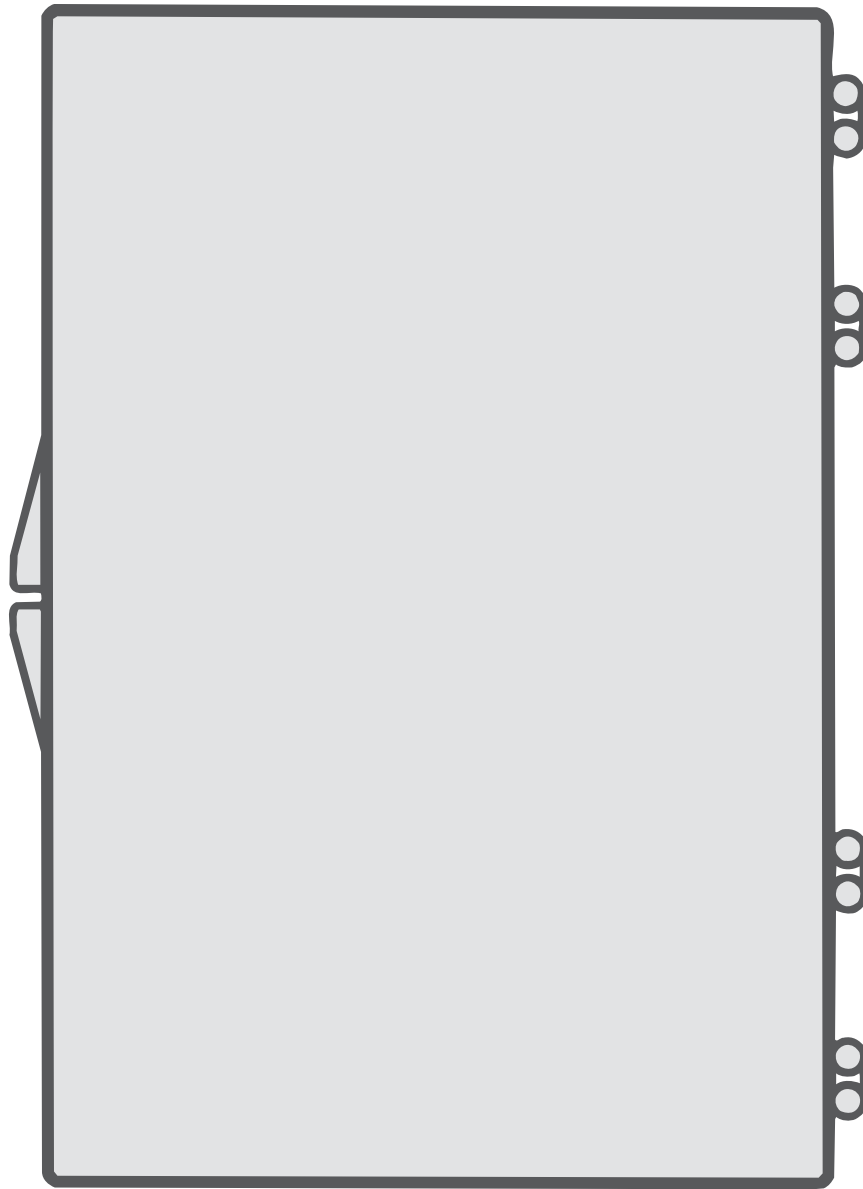

**G2025**  
Stockline



**G2035**  
Stockline

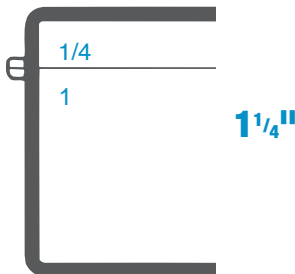

**G2075**  
Stockline

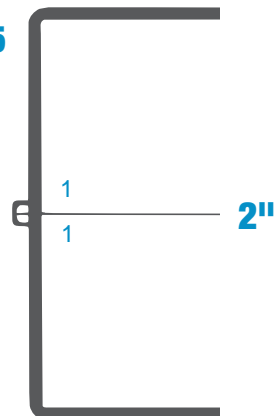

**G2027**  
Special  
Order

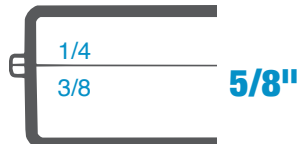

**6<sup>3/32</sup>" x 1<sup>29/32</sup>"**

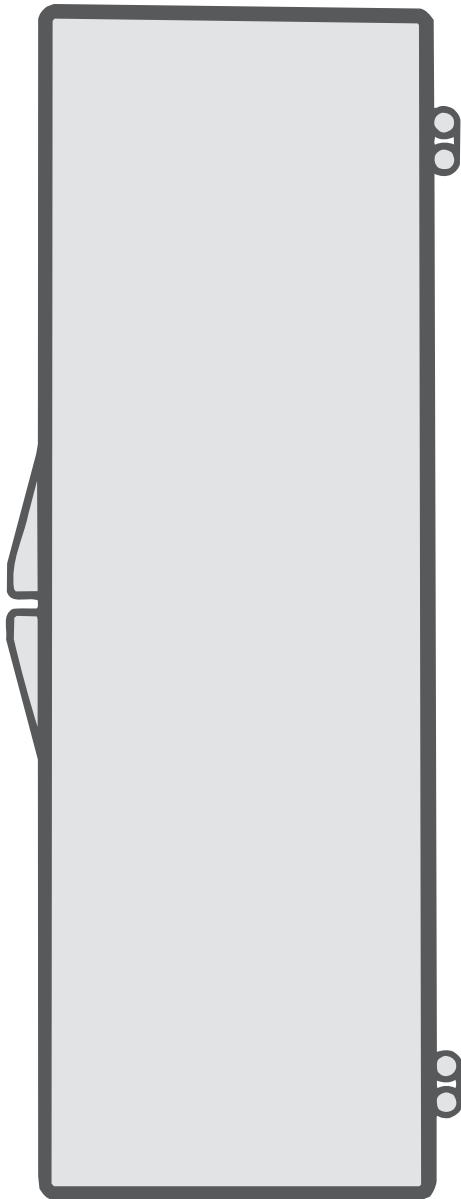

- G1390**  
Special Order



**7/32"**  
Lid: 7/64 Base: 7/64
- G1392**  
Special Order

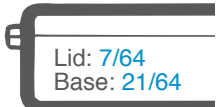

**7/16"**  
Lid: 7/64 Base: 21/64
- G1395**  
Special Order

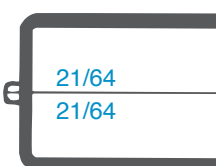

**21/32"**  
21/64  
21/64

**6<sup>1/8</sup>" x 2<sup>9/32</sup>"**

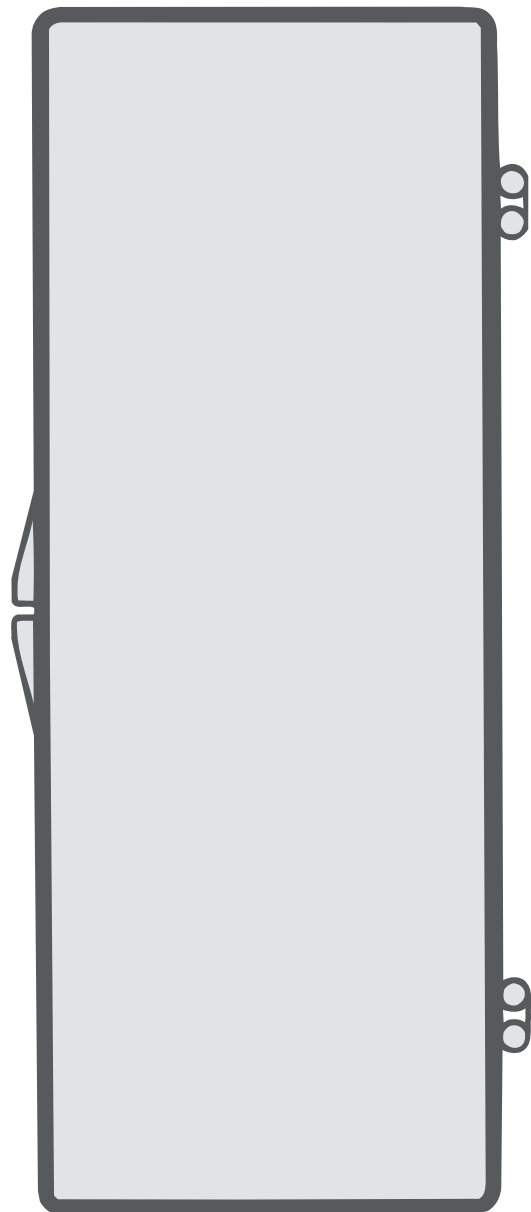

- G1770**  
Special Order

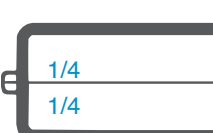

**1/2"**  
1/4  
1/4
- G1775**  
Special Order

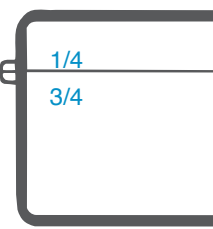

**1"**  
1/4  
3/4
- G1310**  
Stockline

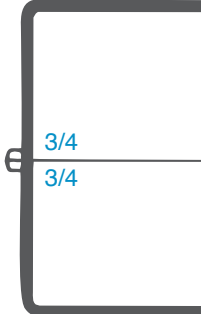

**1 1/2"**  
3/4  
3/4

# 36 Stock Hinged Containers

6<sup>3</sup>/<sub>4</sub>" x 3<sup>1</sup>/<sub>2</sub>"

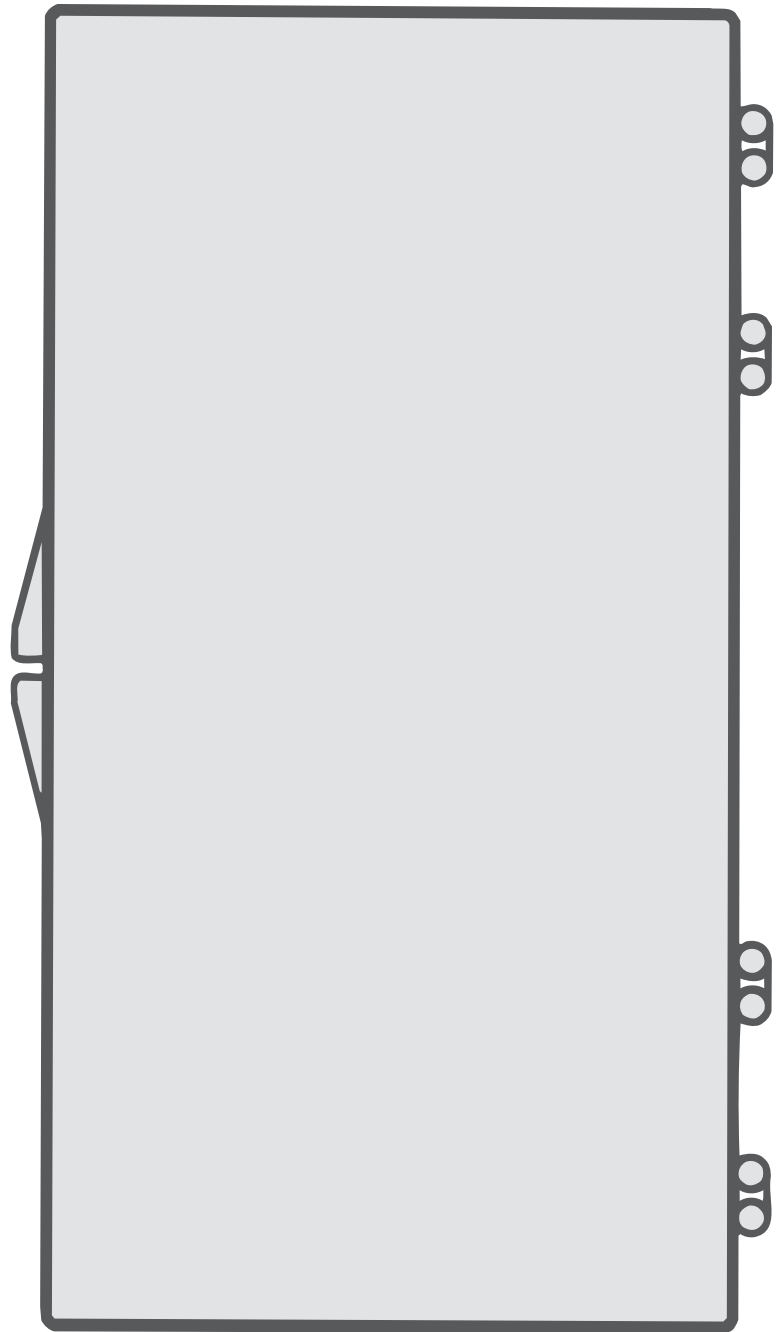

**G1700**  
Stockline  
1/8  
1/8  
**1/4"**

**G1730**  
Stockline  
1/8  
7/8  
**1"**

**G1750**  
Stockline  
7/8  
7/8  
**1<sup>3</sup>/<sub>4</sub>"**

**7" x 3 1/2"**

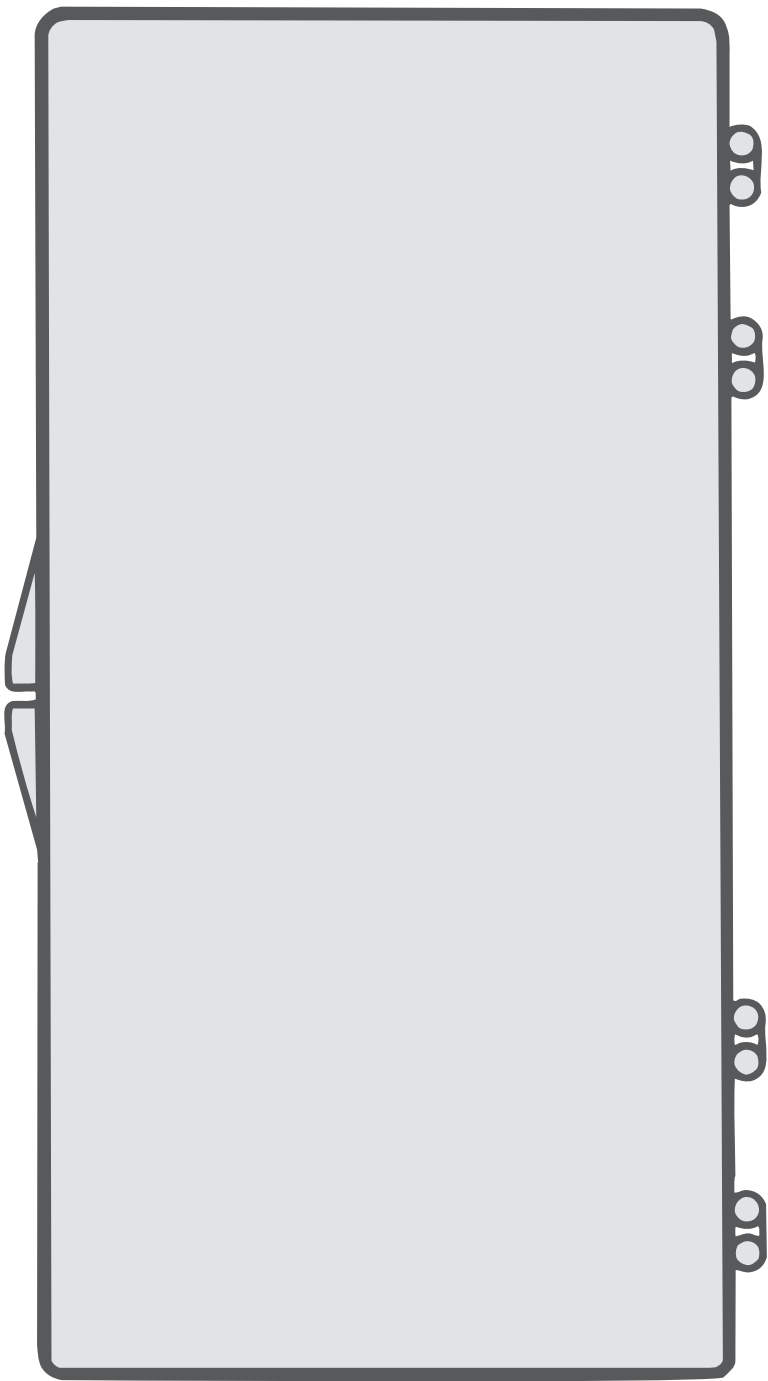

**G2085**  
Stockline  **1/2"**

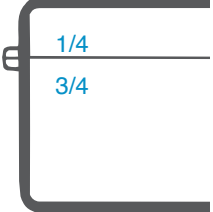
**G2090**  
Stockline  **1"**

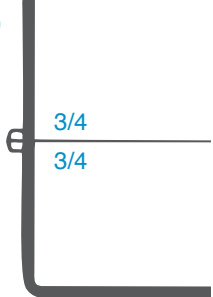
**G2095**  
Stockline  **1 1/2"**



# 38 | Stock Hinged Containers

7" x 5"

**G2100**  
Stockline  
1/8  
1/8  
**1/4"**

**G2125**  
Stockline  
1/8  
7/8  
**1"**

**G2140**  
Stockline  
7/8  
7/8  
**1 3/4"**

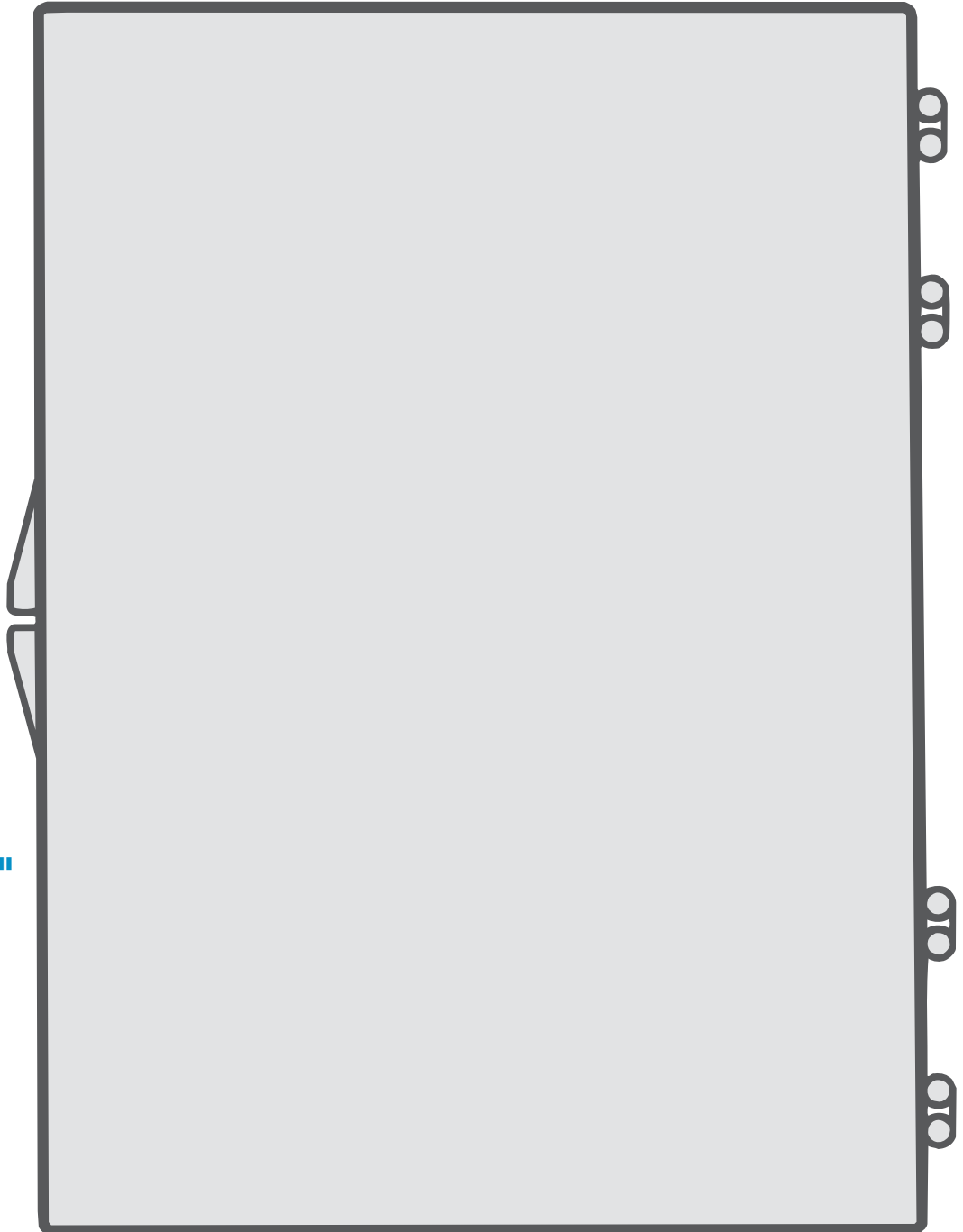

**7 1/4" x 3 1/2"**

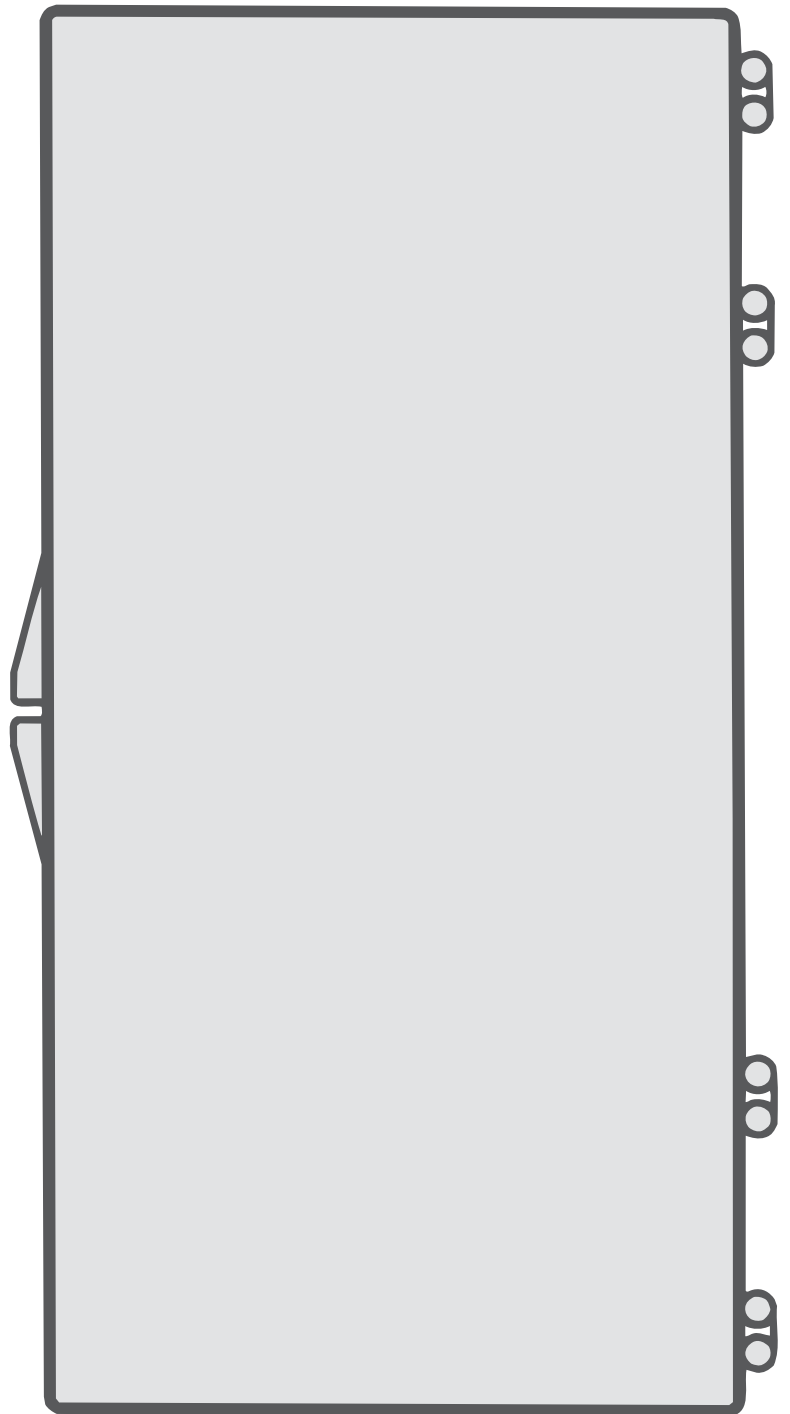

**G2250**  
Stockline

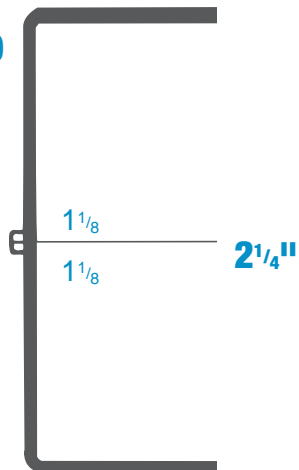

# 40 Stock Hinged Containers

$7\frac{3}{8}'' \times 4\frac{29}{32}''$

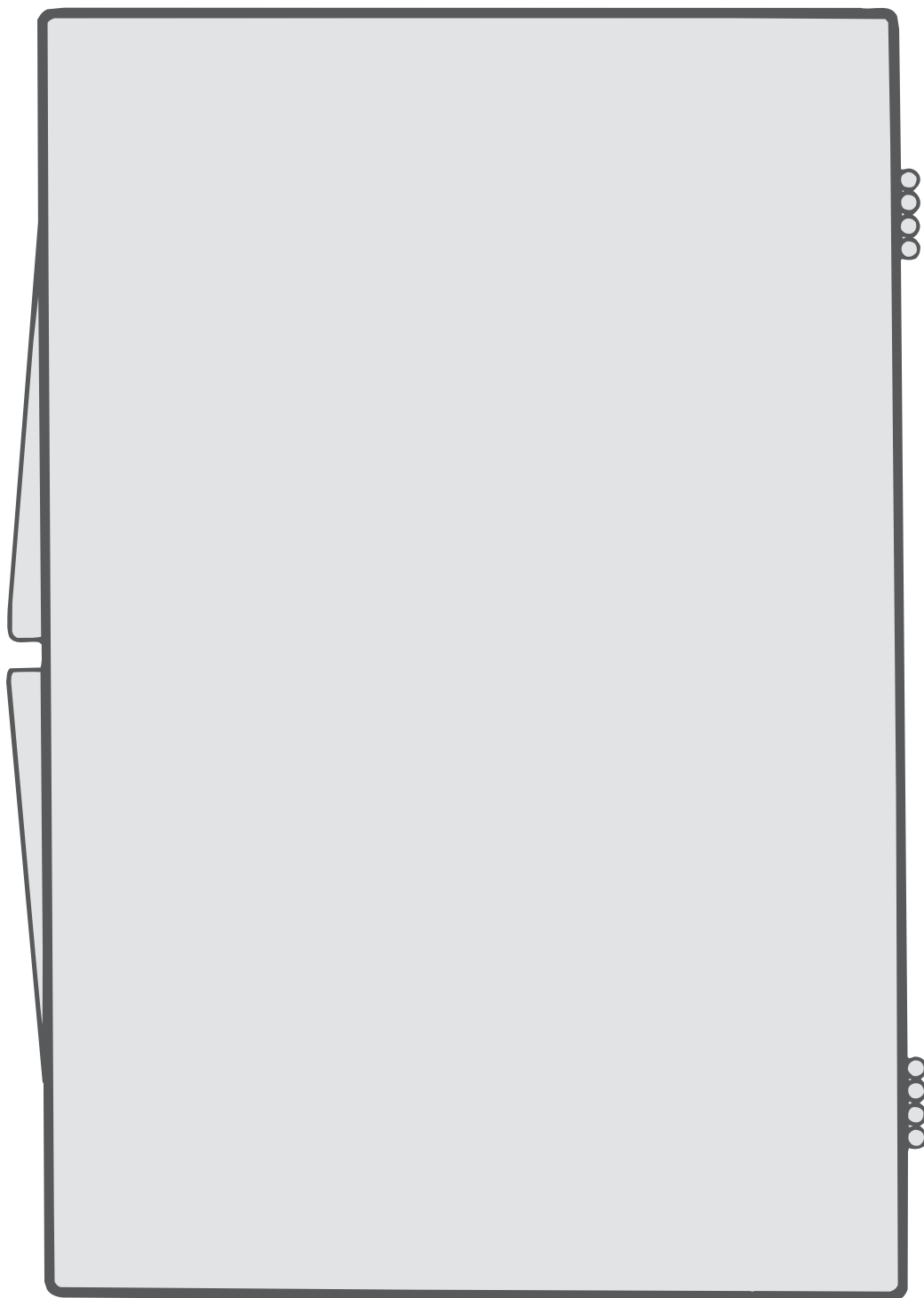

Continued on next page

Continued **7<sup>3</sup>/<sub>8</sub>" x 4<sup>29</sup>/<sub>32</sub>"**

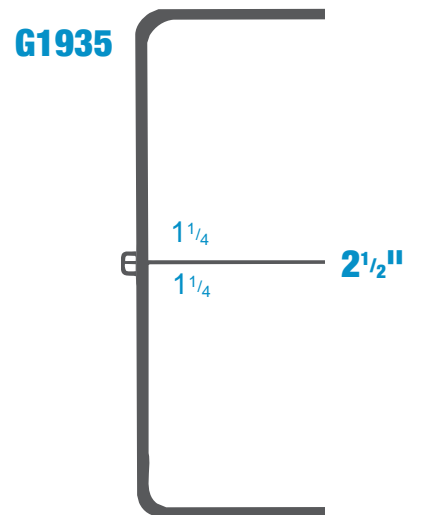
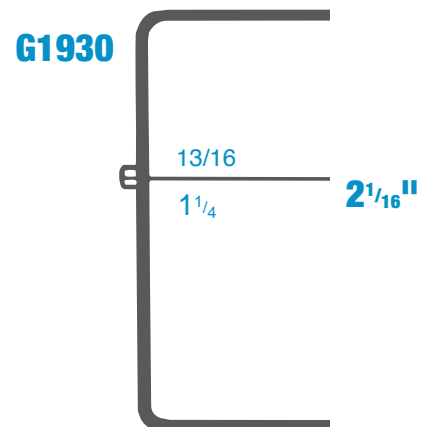
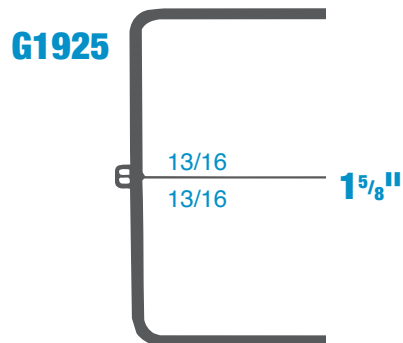
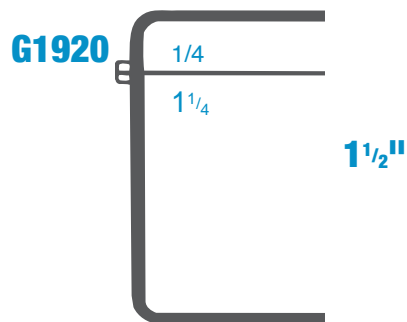
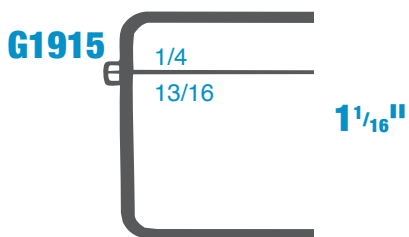
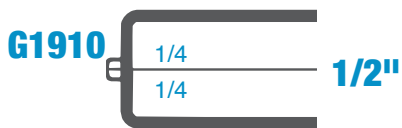

# 42 | Stock Hinged Containers

7<sup>1</sup>/<sub>2</sub>" x 1<sup>1</sup>/<sub>2</sub>"

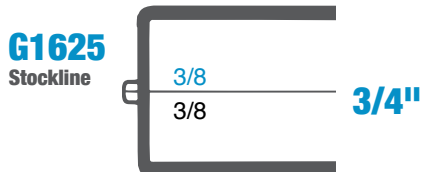
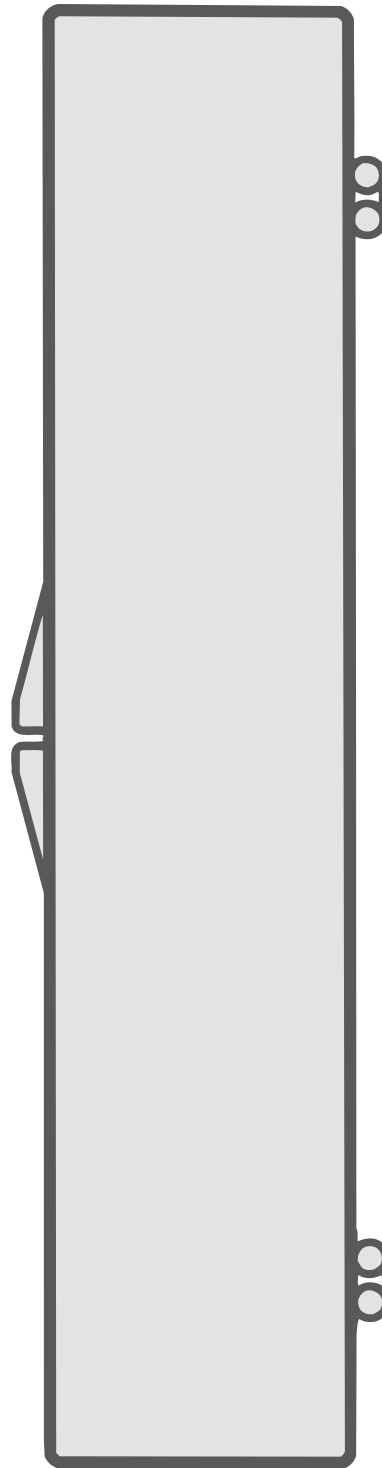

**Metal Pin Hinged**

**8<sup>1</sup>/<sub>8</sub>" x 6<sup>1</sup>/<sub>4</sub>"**

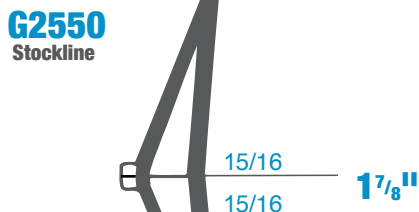
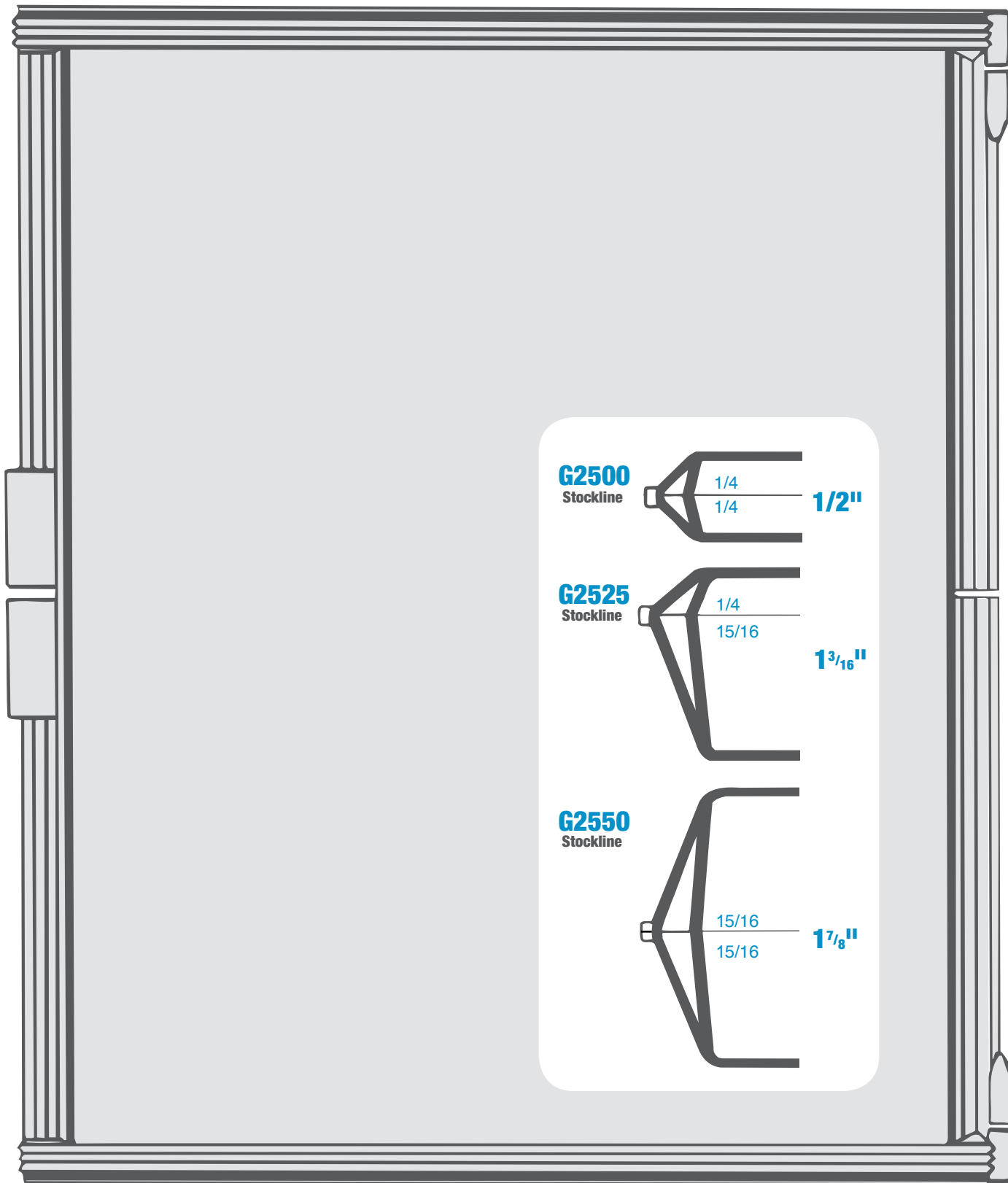

# 44 | Stock Hinged Containers

9 1/2" x 3 1/2"

Ribbed side walls

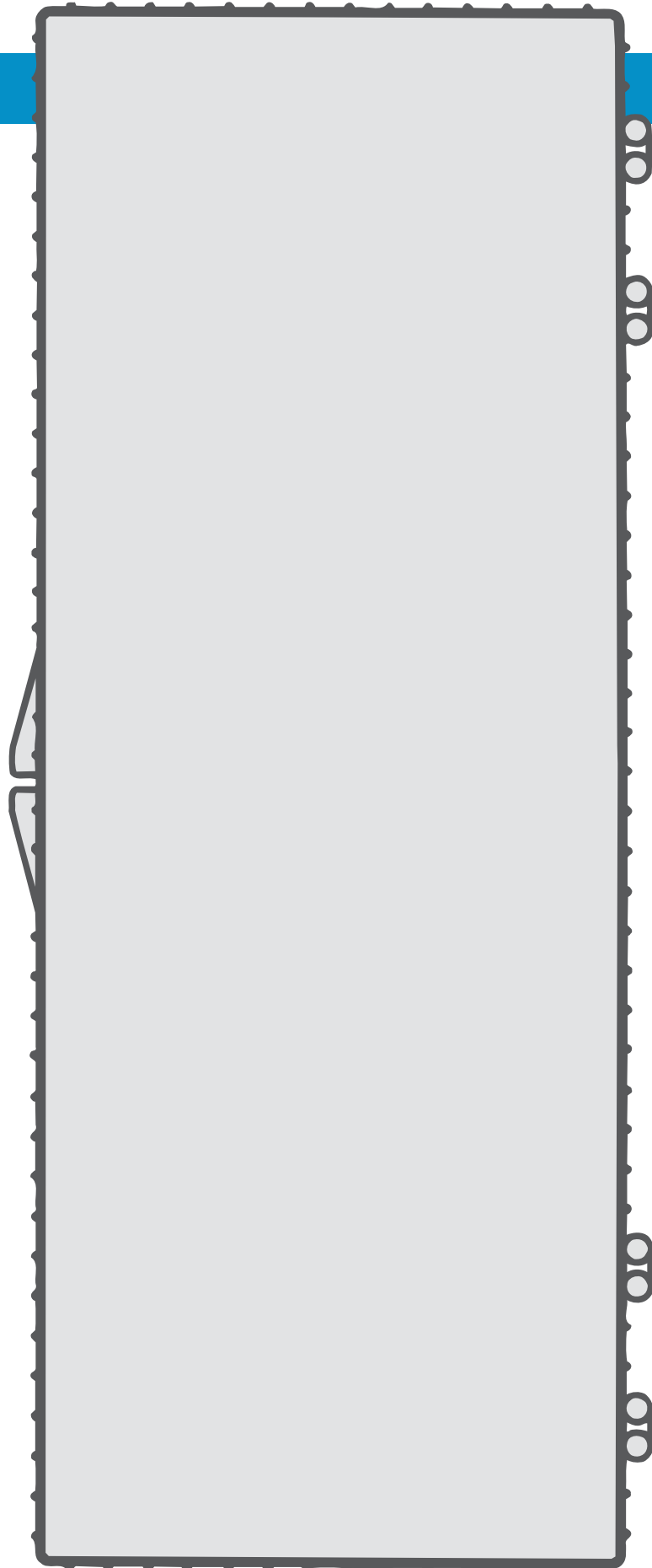

**G2280**  
Stockline

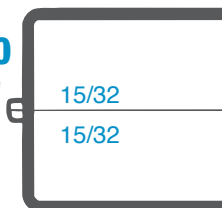

15/16"

Stock Hinged Containers | **45**

**9<sup>15</sup>/<sub>16</sub>" x 3<sup>1</sup>/<sub>2</sub>"**

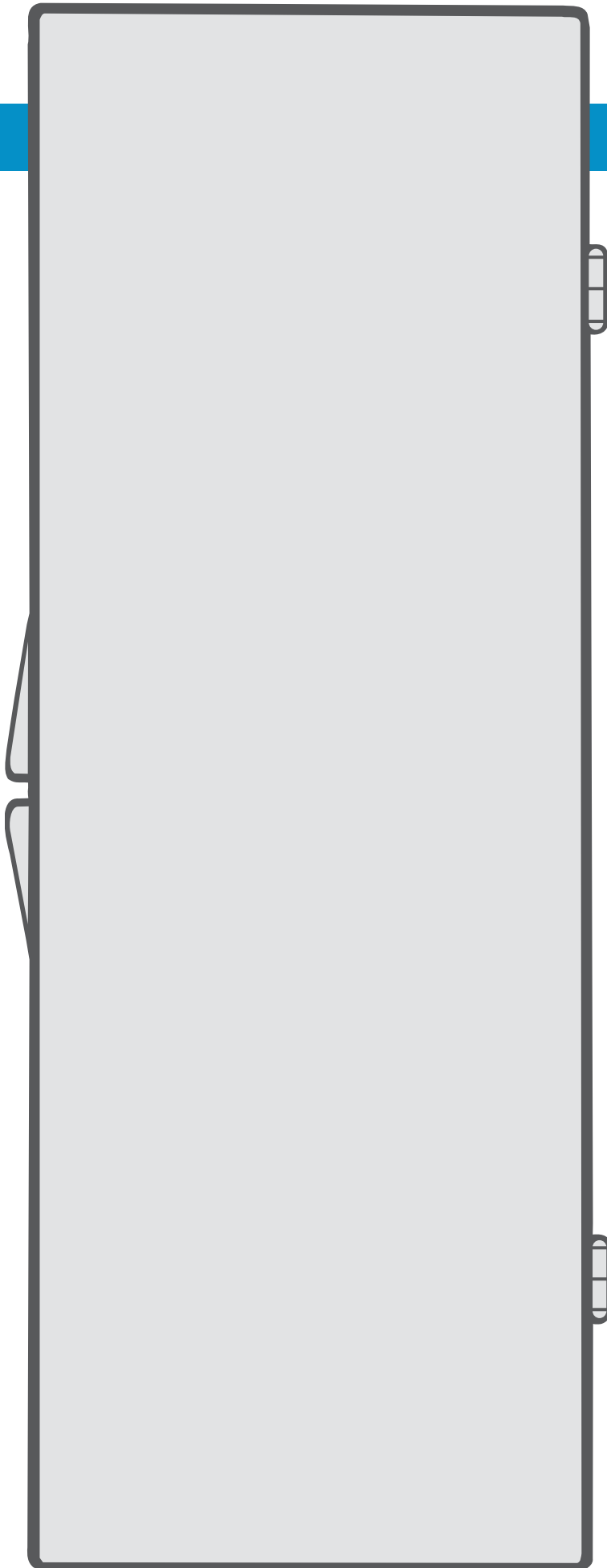

**G1980**

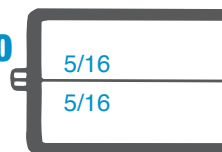

5/16

5/16

**5/8"**



# 46 | Stock Hinged Containers

**10<sup>3/8</sup>" x 6" Metal Hinged**

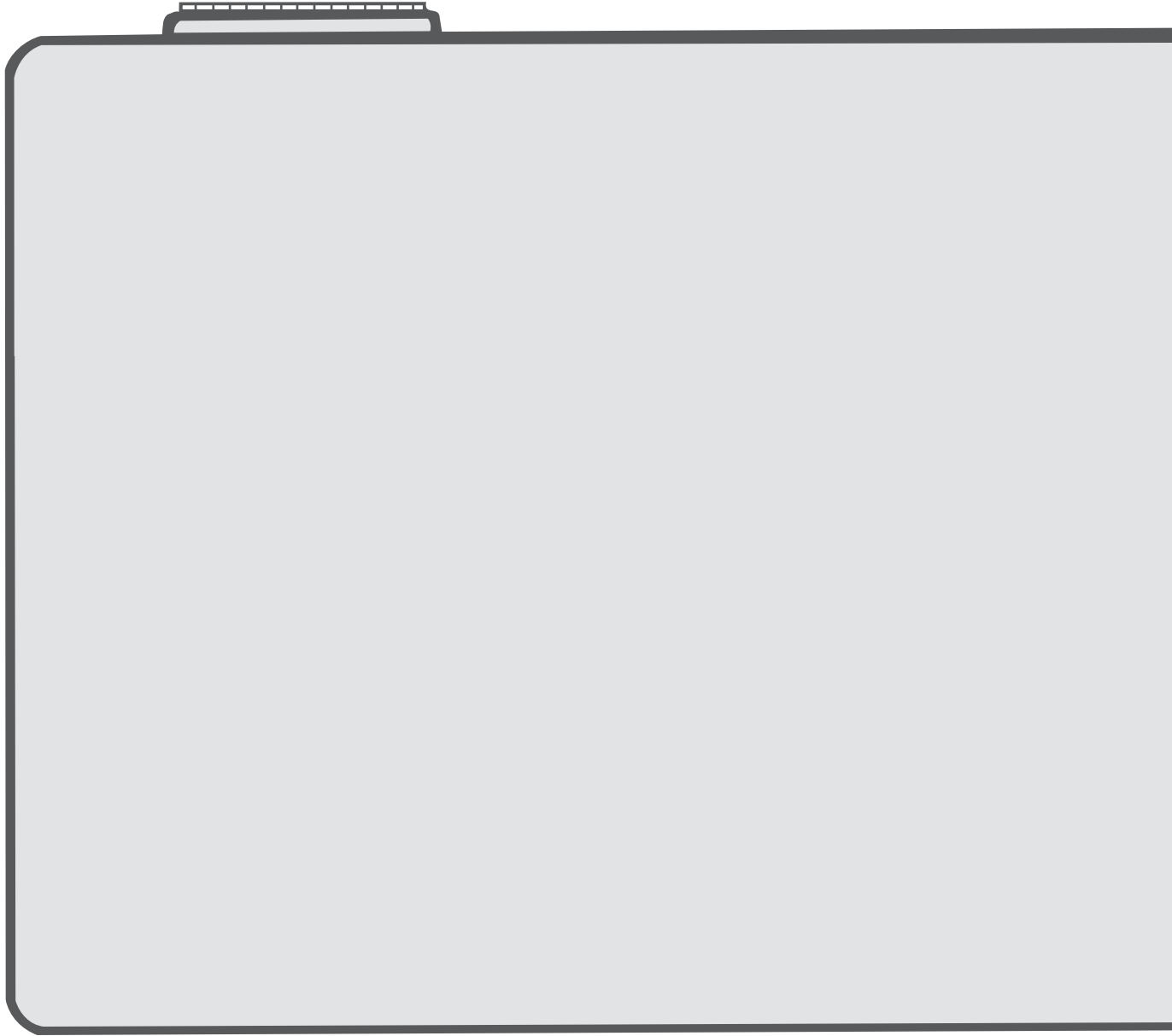

**10<sup>3/8</sup>" x 6"**

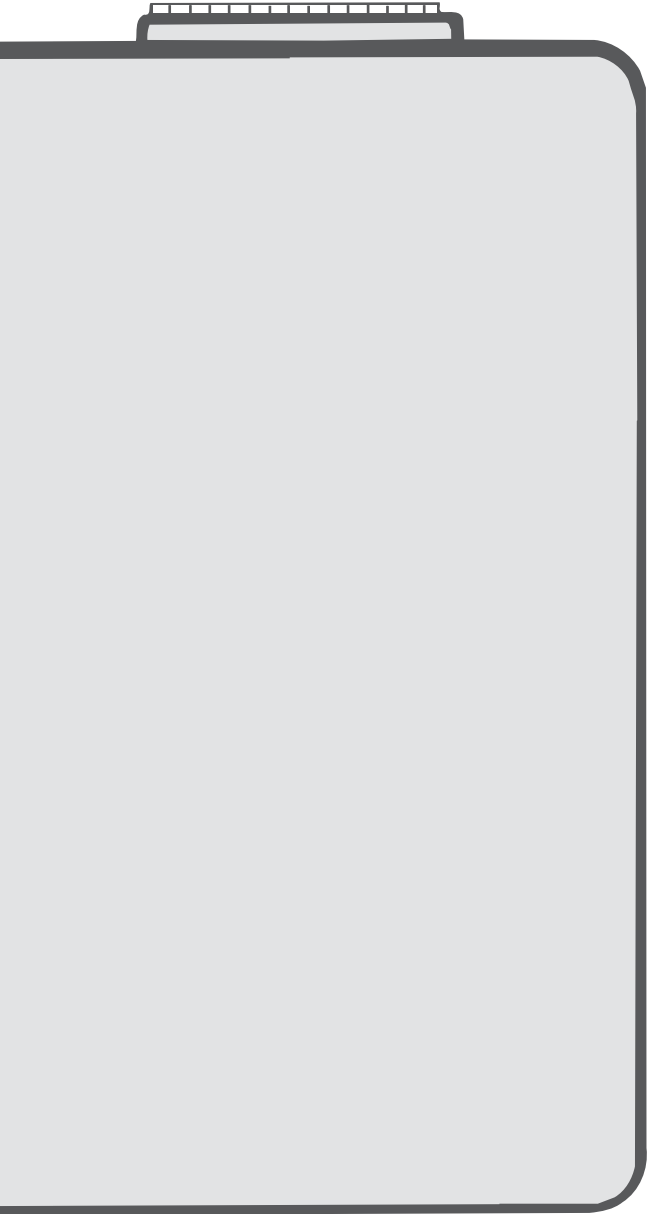

**G2600**  
Stockline

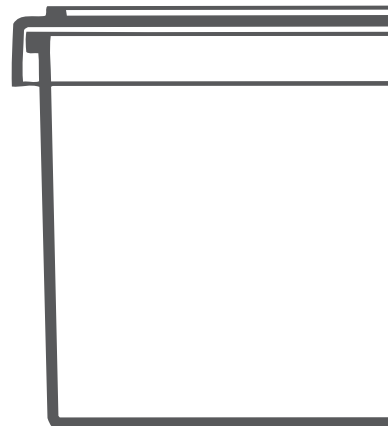

**2"**

# 48 | Stock Unhinged Containers

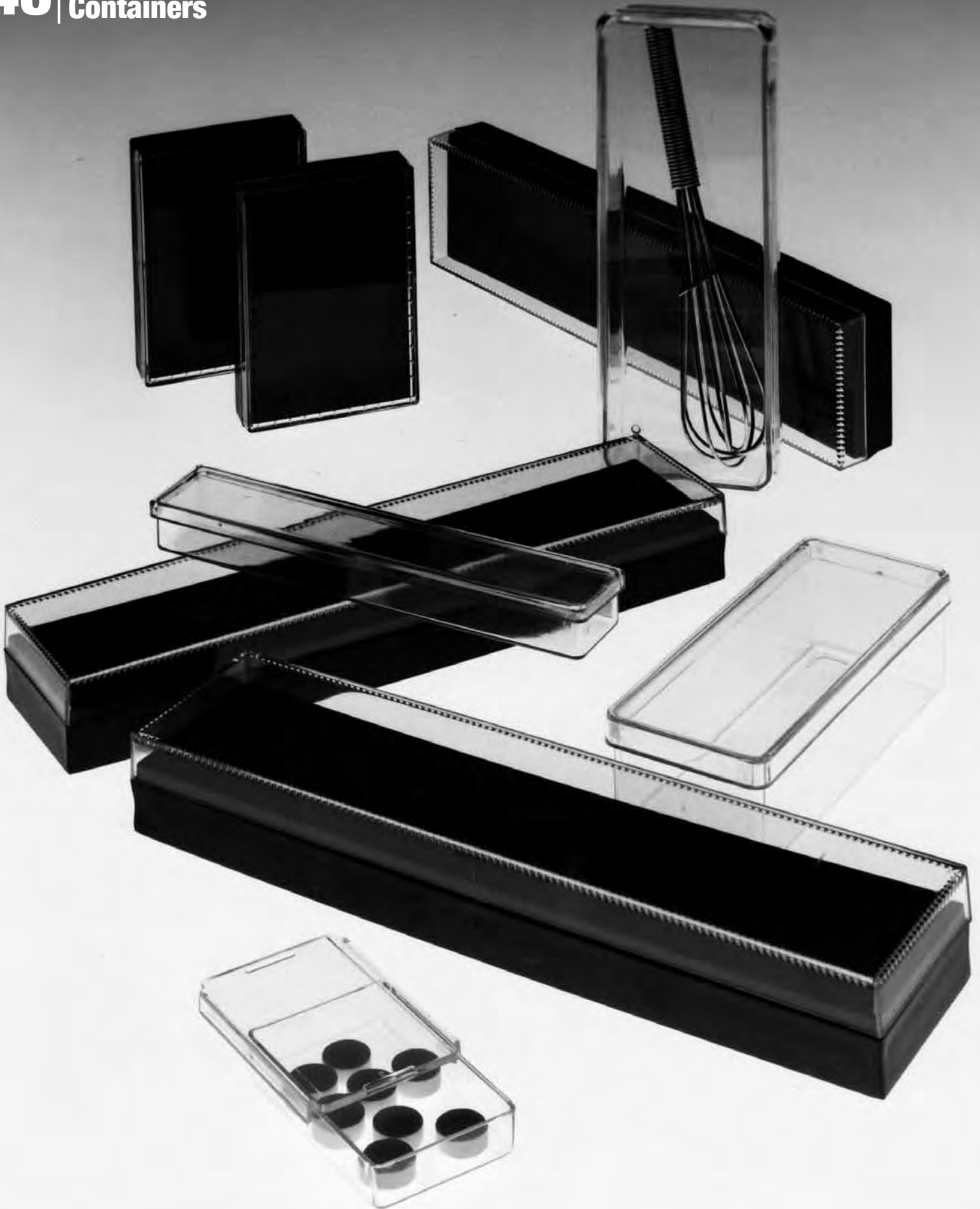

**1<sup>11/16</sup>" x 3/4"**

**1<sup>3/4</sup>" x 1<sup>3/4</sup>"**

**2" x 1<sup>1/4</sup>"**

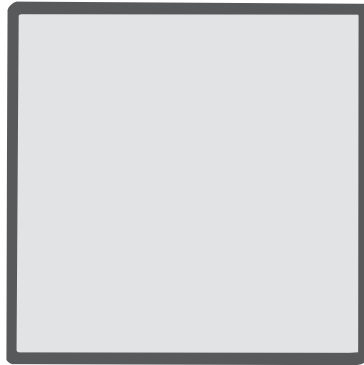

**Box with slide on cover**

**505**  
Special  
Order



**5/8"**

**510**  
Special  
Order



**11/16"**

**500**  
Special  
Order

End view with slide top

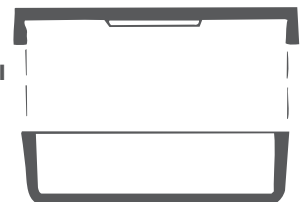

**5/16"**

# 50 Stock Unhinged Containers

Friction-fit covers

2" x 2"

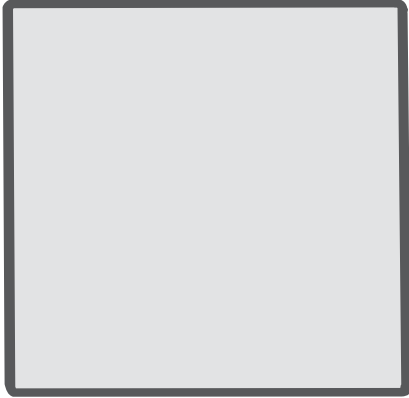

2 1/2" x 2 1/2"

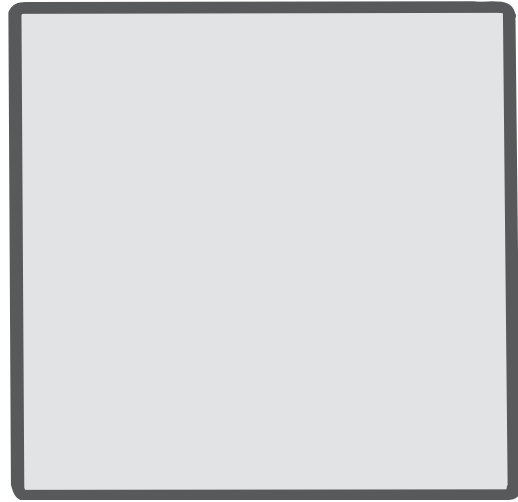

**512**  
Special  
Order



3/4"

**514**  
Special  
Order



7/8"

**3" x 2<sup>1</sup>/<sub>8</sub>"**

**3<sup>3</sup>/<sub>8</sub>" x 3<sup>3</sup>/<sub>8</sub>"**

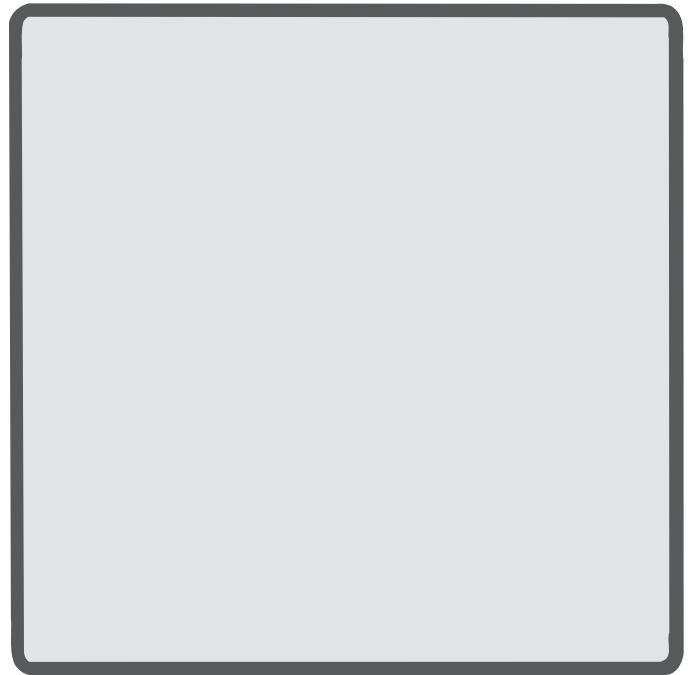

**502**

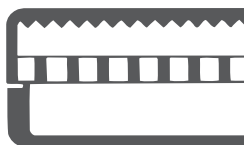

**19/32"**

**516**  
Special  
Order

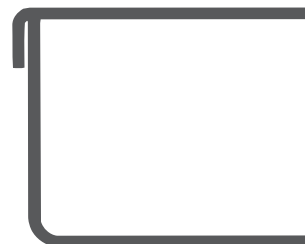

**1<sup>1</sup>/<sub>8</sub>"**

# 52 Stock Unhinged Containers

Friction-fit covers

$4\frac{1}{4}'' \times 1\frac{1}{2}''$

$4\frac{5}{16}'' \times 4\frac{5}{16}''$

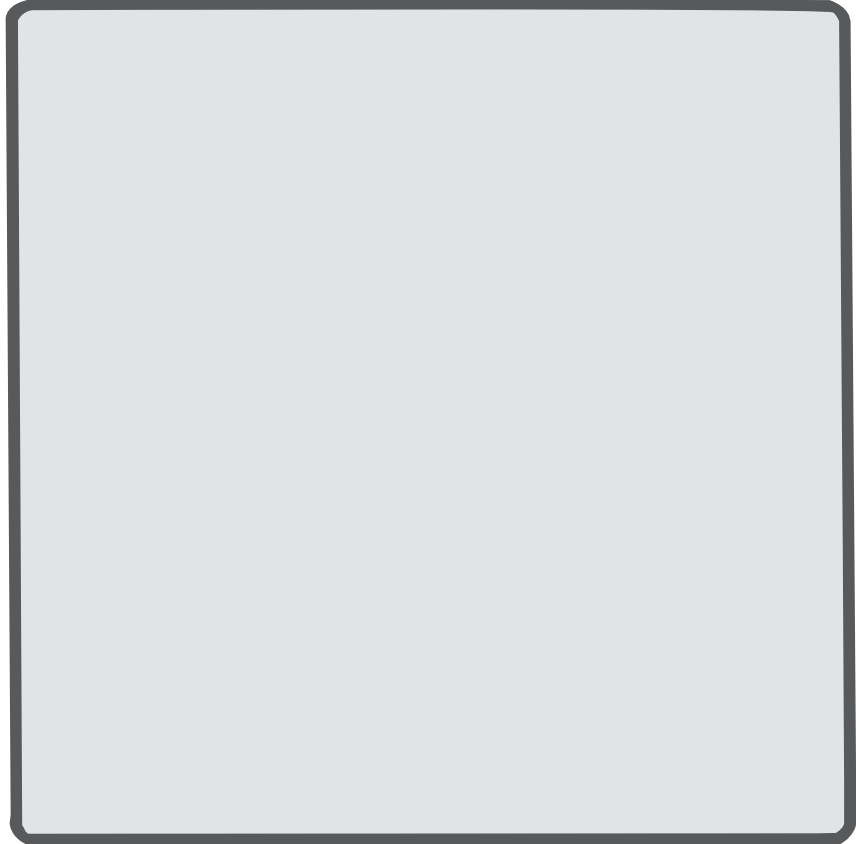

**504**  
Stockline

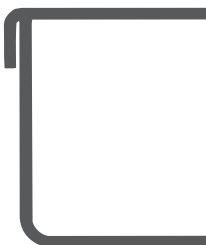

$1\frac{1}{8}''$

**519**  
Special  
Order



$1\frac{3}{8}''$

**5 1/4" x 5"**

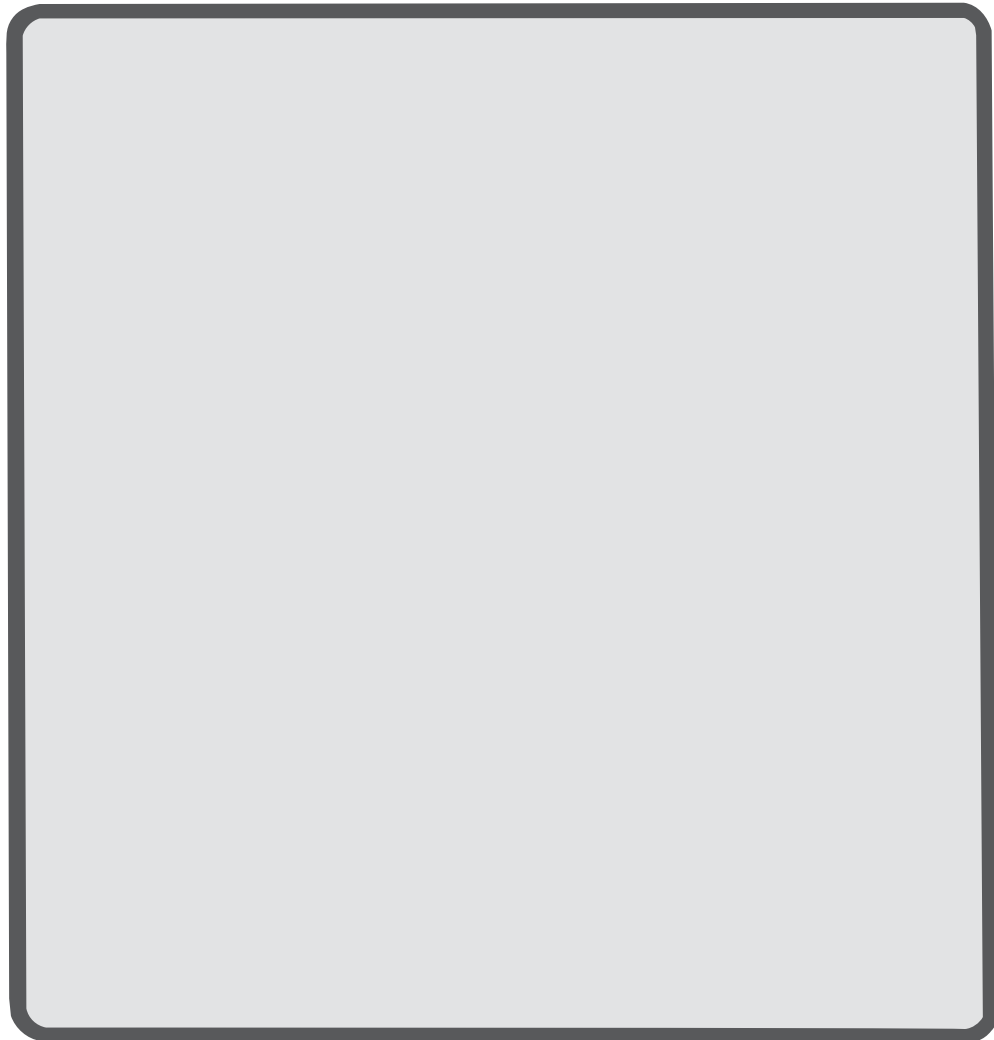

**523**



**1 3/8"**



# 54 | Stock Unhinged Containers

Friction-fit covers

5 1/2" x 2"



**507**  
Stockline



1 1/16"

**Stock Unhinged Containers | 55**

Friction-fit covers

**9 1/2" x 3 1/2"**

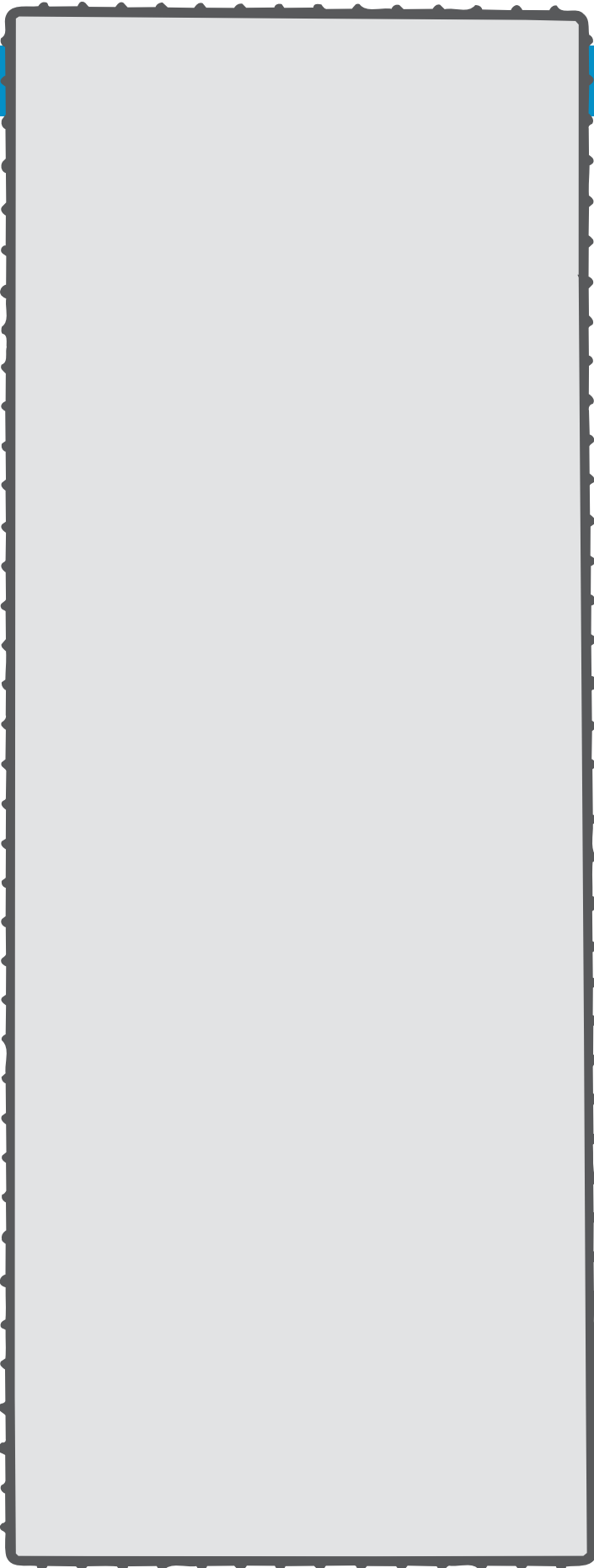

**Ribbed side walls**

**524**

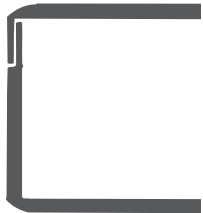

**15/16"**

# 56 Stock Unhinged Containers

Friction-fit covers

**9<sup>1</sup>/<sub>2</sub>" x 3<sup>9</sup>/<sub>16</sub>"**

**522**



**2<sup>1</sup>/<sub>2</sub>"**

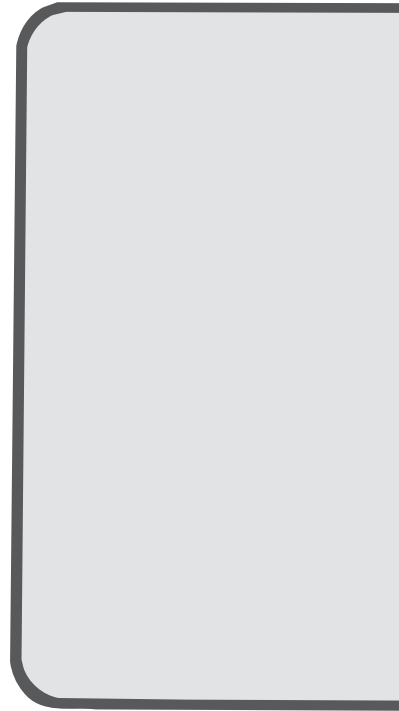

**9<sup>13</sup>/<sub>16</sub>" x 3<sup>7</sup>/<sub>16</sub>"**

**511**  
Special  
Order



**9/16"**

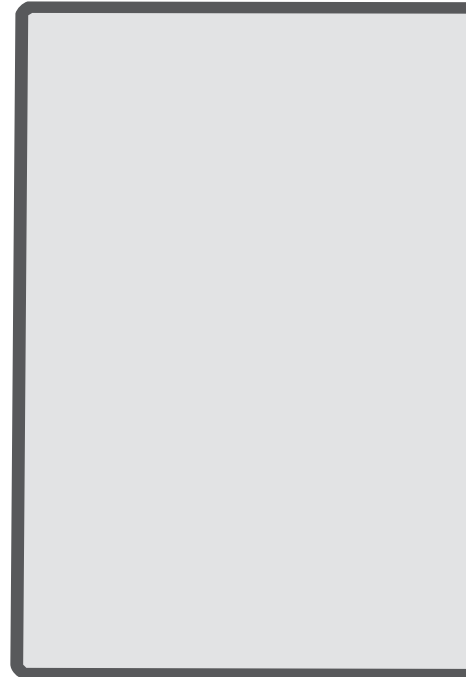

**9<sup>1</sup>/<sub>2</sub>" x 3<sup>9</sup>/<sub>16</sub>"**

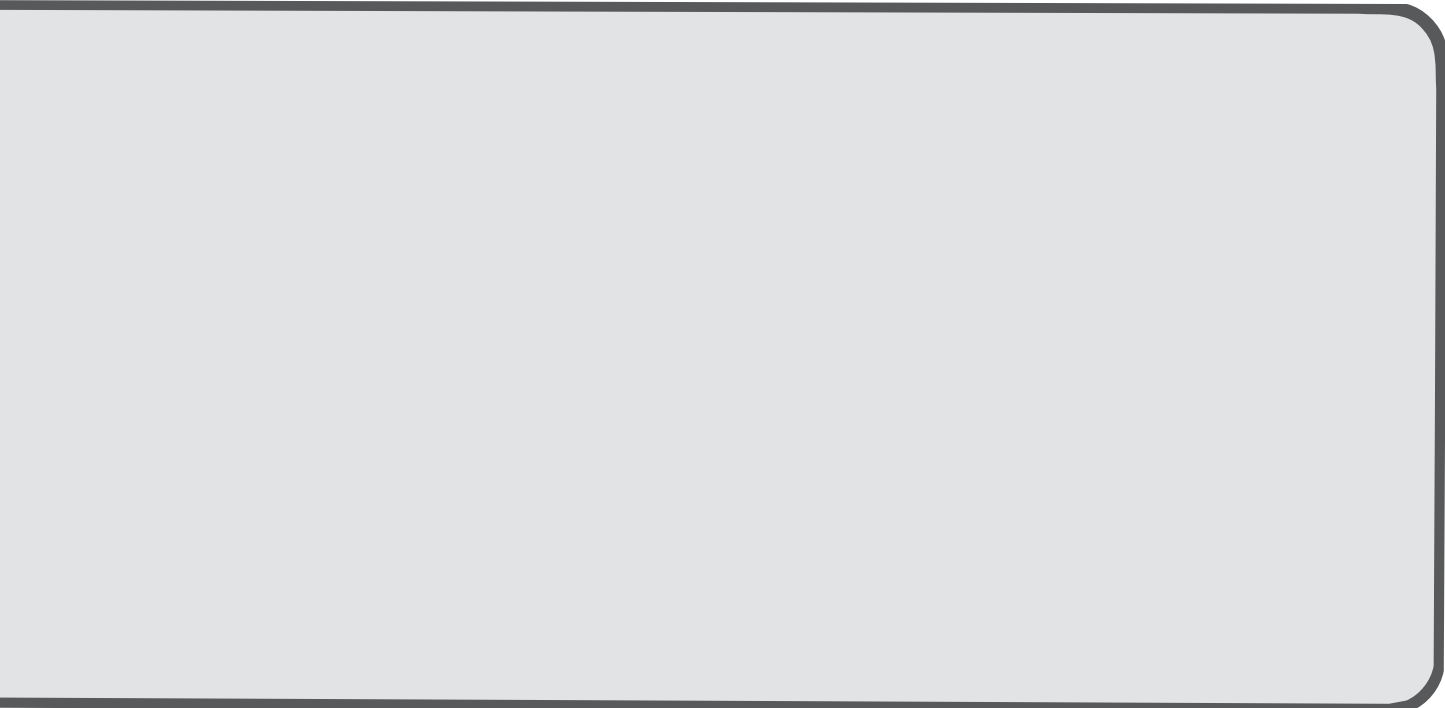

**9<sup>13</sup>/<sub>16</sub>" x 3<sup>7</sup>/<sub>16</sub>"**



# 58 | Stock Round Containers



**1<sup>3</sup>/<sub>8</sub>"** Diameter

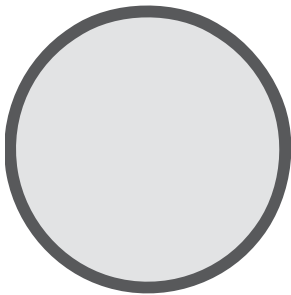

**701R**  
Stockline



**1<sup>5</sup>/<sub>8</sub>"** Diameter

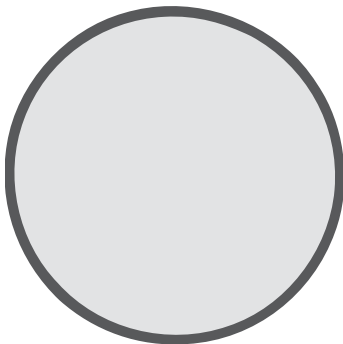

**702R**  
Special  
Order



**1/2"**

**2<sup>1</sup>/<sub>2</sub>"** Diameter

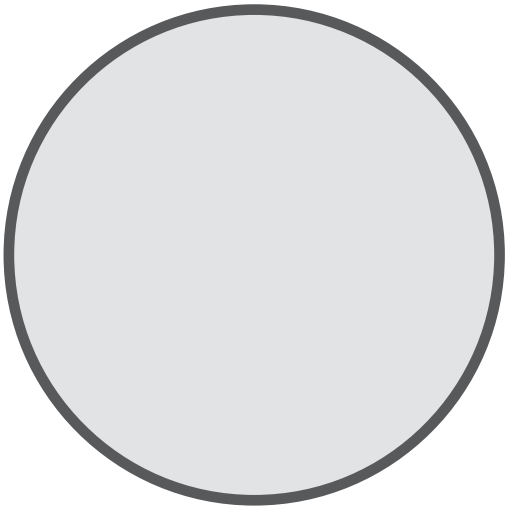

**705R**  
Stockline

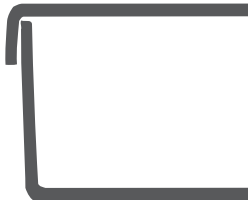

**7/8"**

**2<sup>23</sup>/<sub>32</sub>"** Diameter

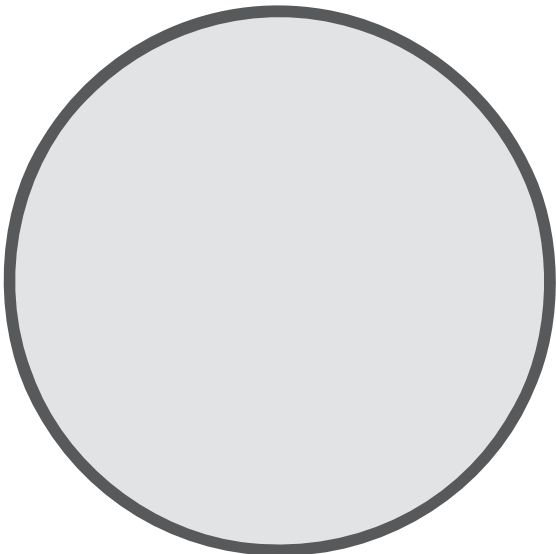

**709AR**  
Special  
Order



**5/8"**

# 60 Stock Round Containers

Friction-fit covers

**3<sup>5</sup>/<sub>16</sub>"** Diameter

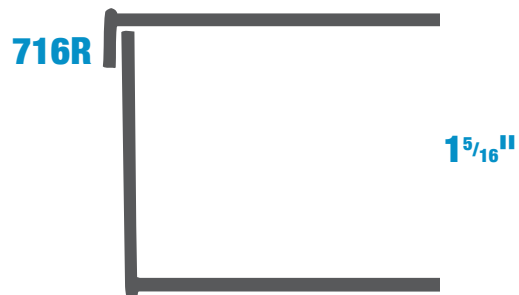
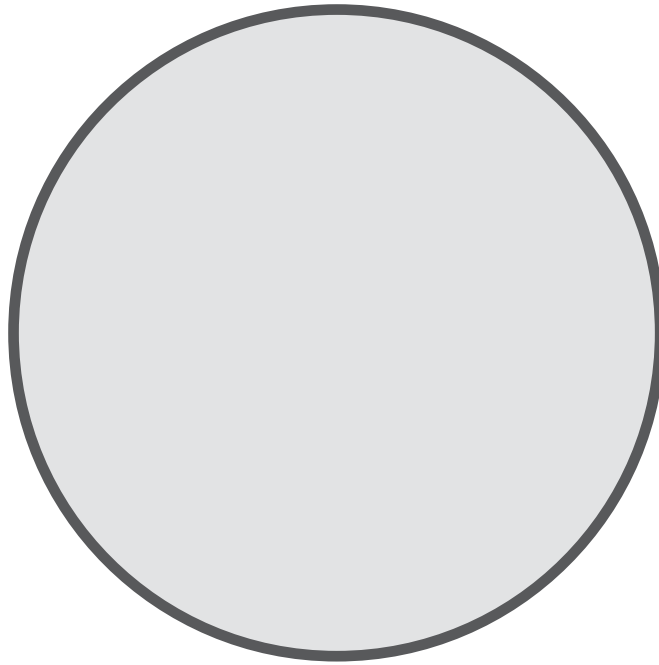

**3<sup>3</sup>/<sub>8</sub>"** Diameter

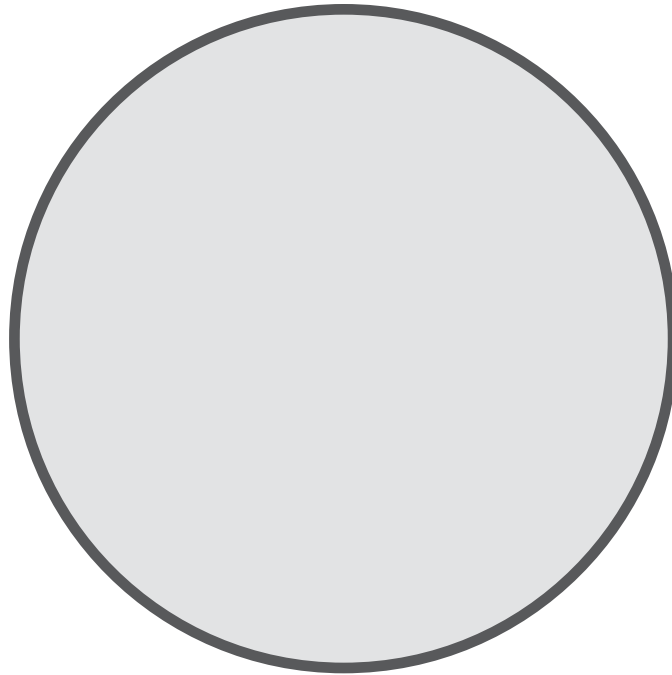

**715R**  
Stockline



**7/8"**



# 62 Stock Round Containers

Friction-fit covers

4<sup>1</sup>/<sub>4</sub>" Diameter

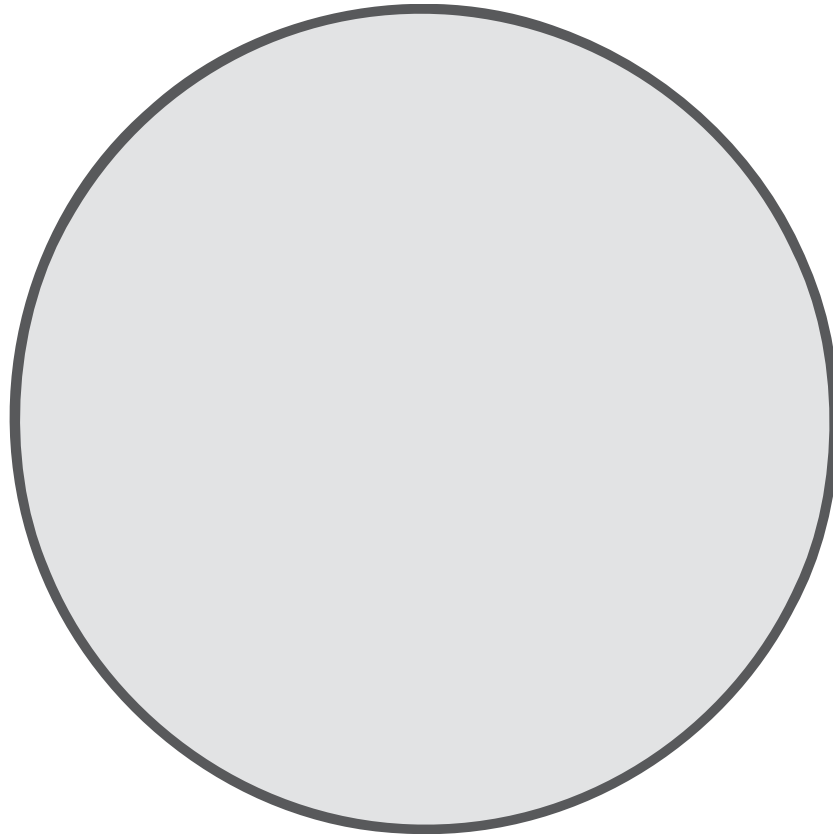

721R



7/8"

**4<sup>1</sup>/<sub>4</sub>"** Diameter

**590**  
Stockline

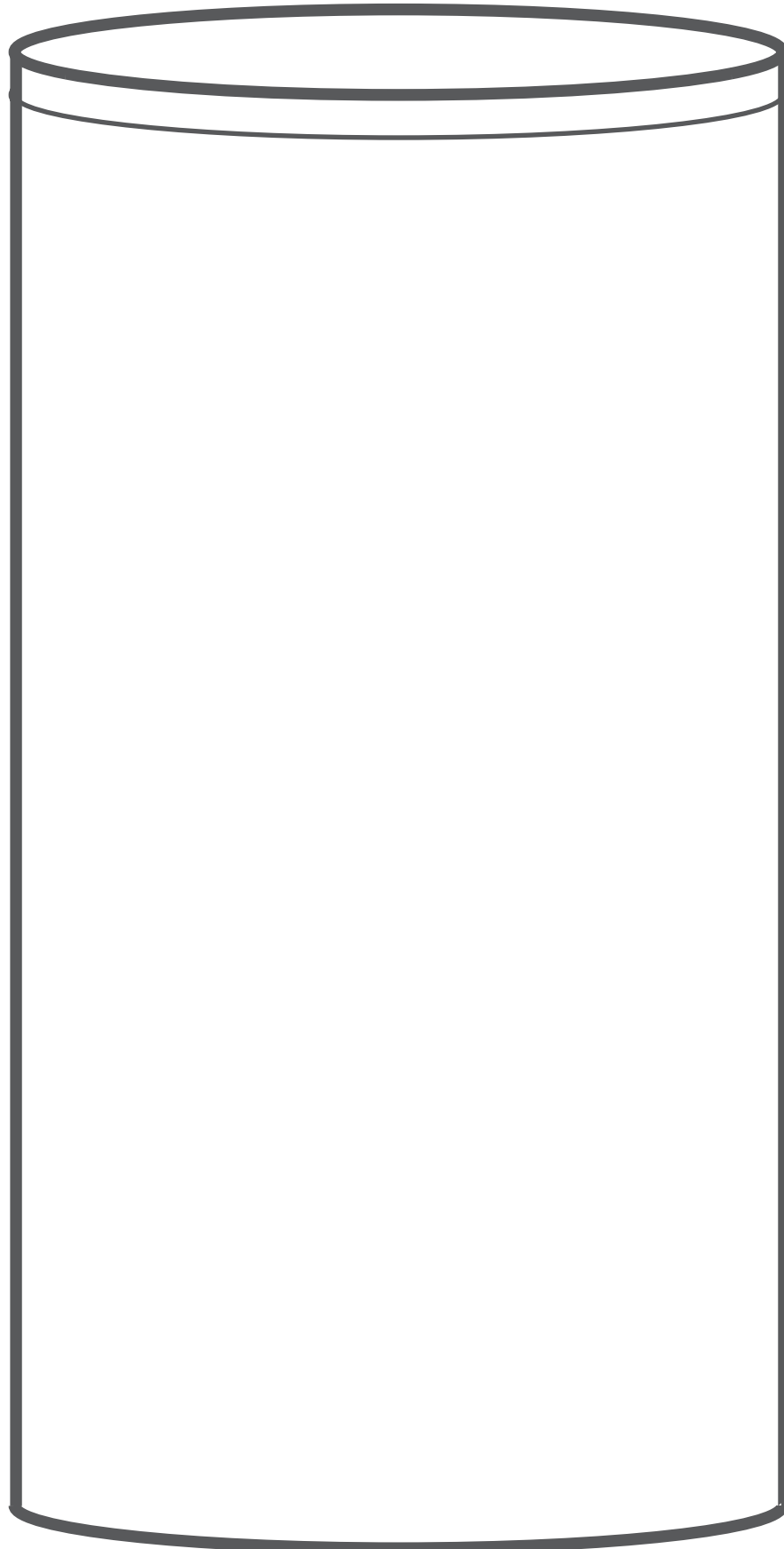

**8<sup>1</sup>/<sub>2</sub>"**

# 64 | Stock Round Containers

Friction-fit covers

**4<sup>5</sup>/<sub>16</sub>"** Diameter

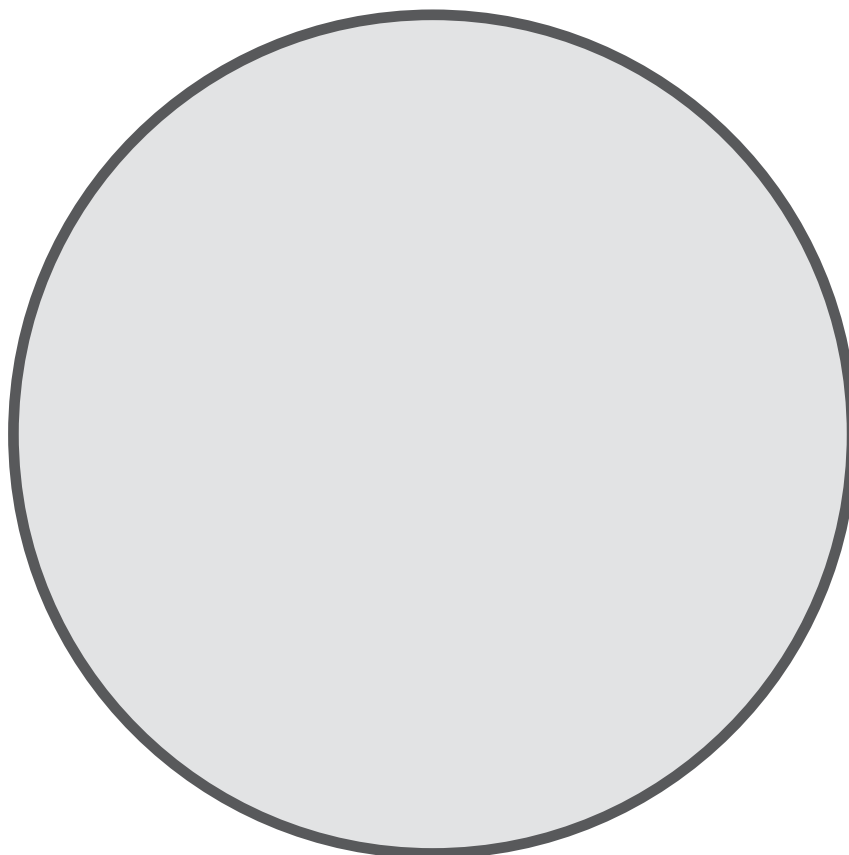

**735R**  
Stockline

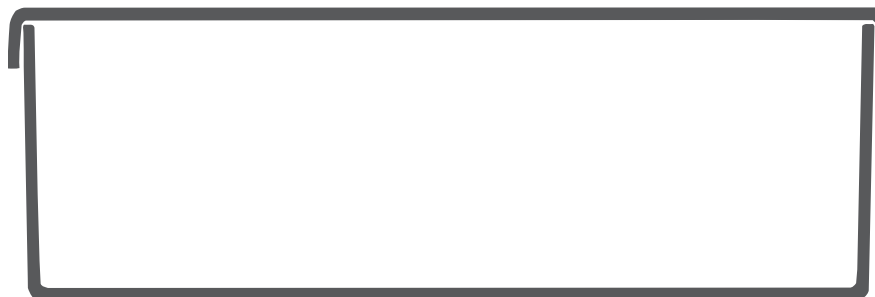

**1<sup>3</sup>/<sub>8</sub>"**

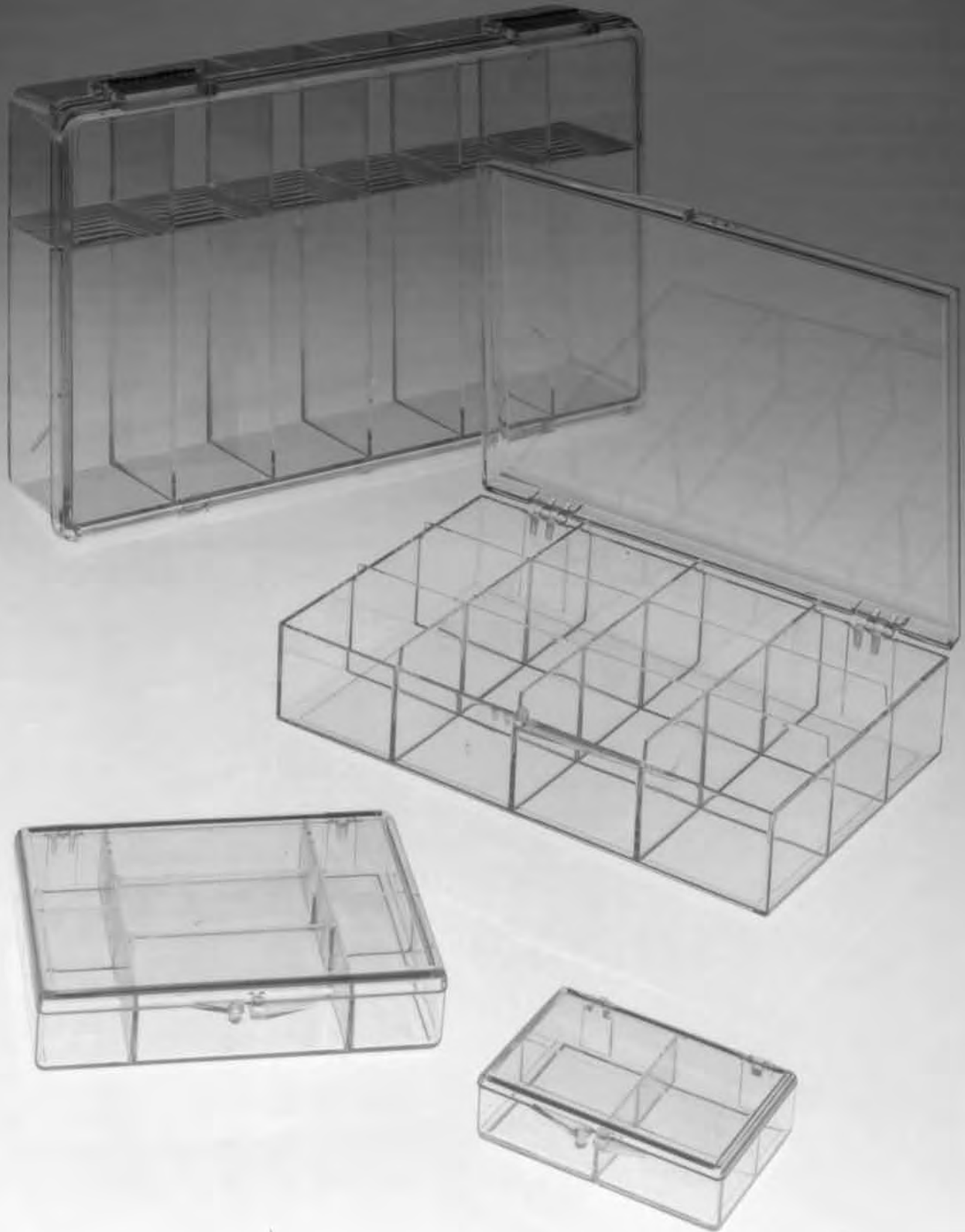

# 66 Stock Compartment Containers

2<sup>7</sup>/<sub>8</sub>" x 2"

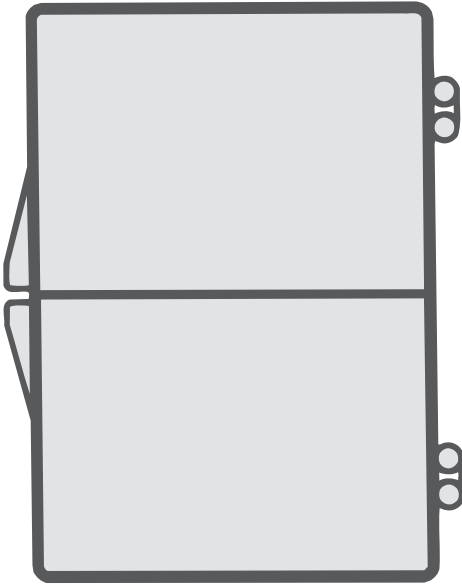

Two Compartments

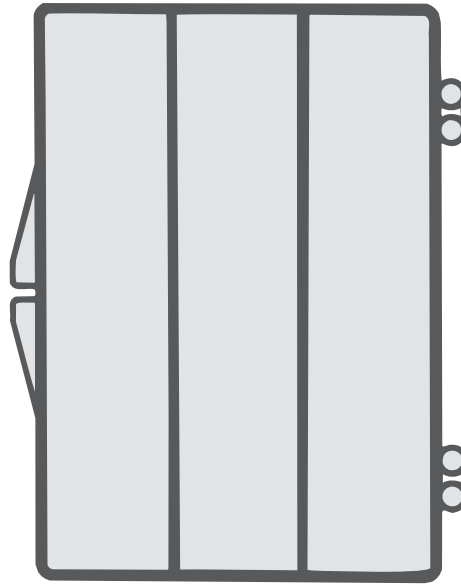

Three Compartments

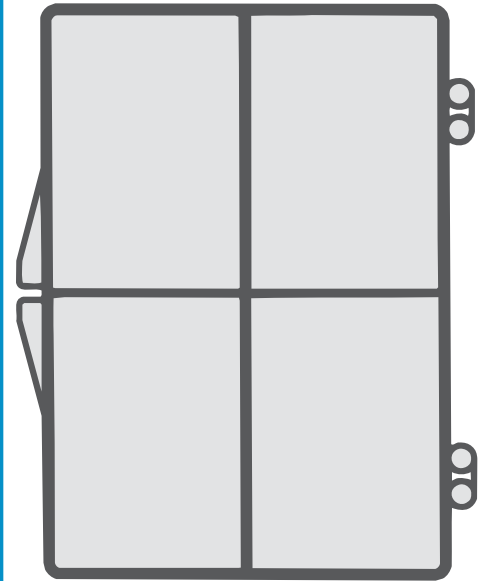

Four Compartments

**G702**  
Special Order



Lid: 1/16  
Base: 1/2

9/16"

**G703**  
Special Order



Lid: 1/16  
Base: 1/2

9/16"

**G704**  
Special Order



Lid: 1/16  
Base: 1/2

9/16"

**4<sup>5</sup>/<sub>8</sub>" x 3<sup>1</sup>/<sub>2</sub>"**

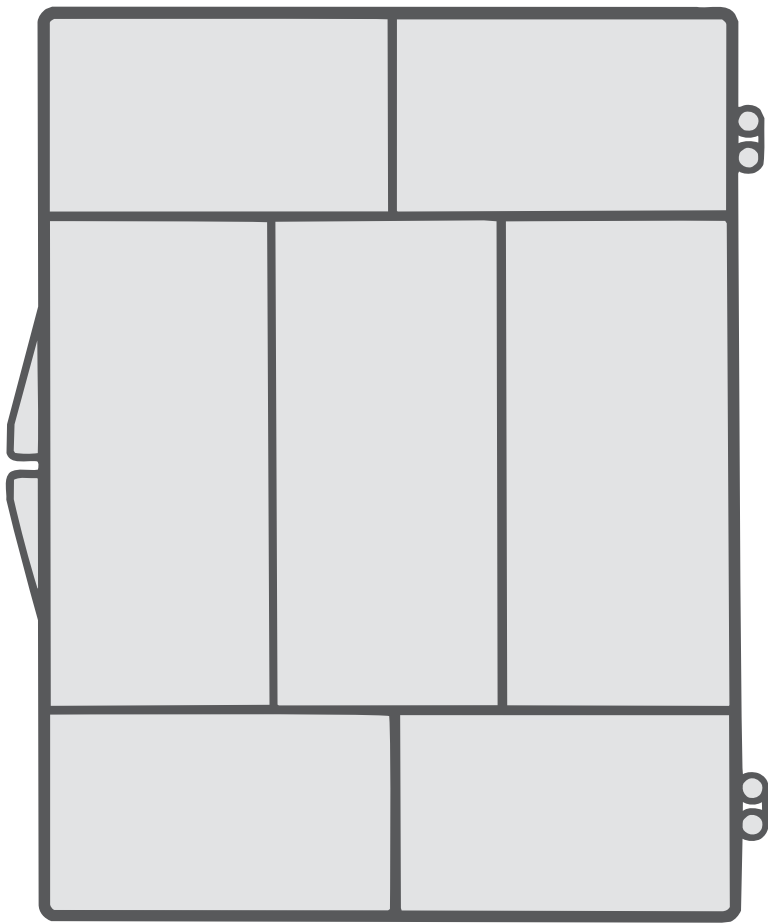

**Seven Compartments**

**G1157**  
Stockline

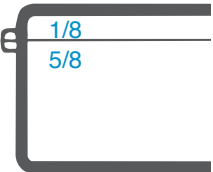

**3/4"**

**G1177**

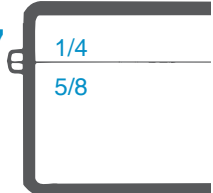

**7/8"**

# 68 | Stock Compartment Containers

$5\frac{5}{32}'' \times 3\frac{3}{16}''$

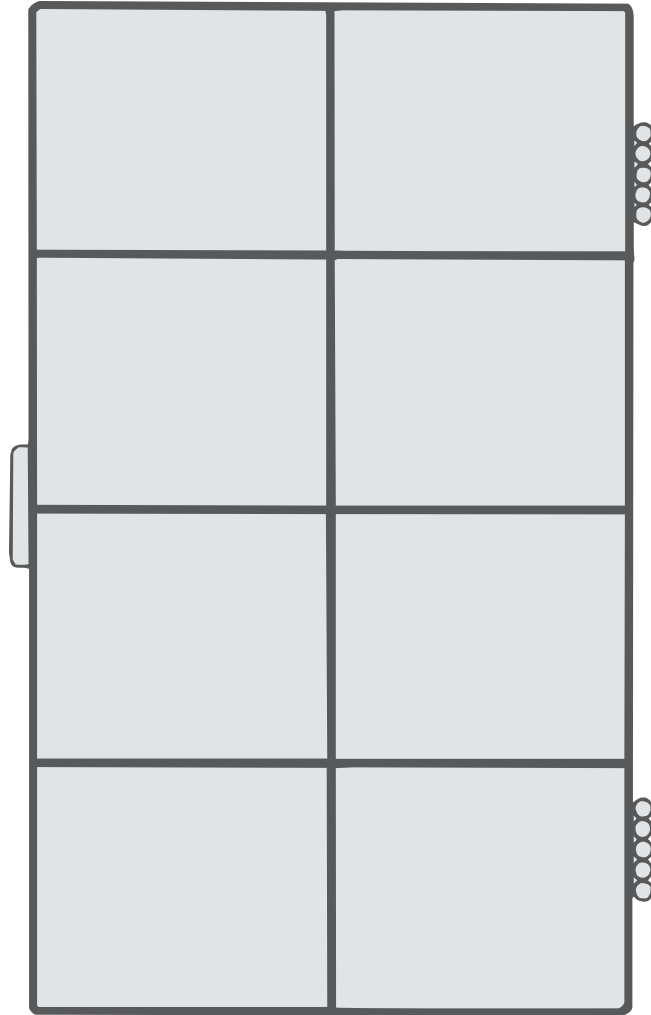

**Eight Compartments**

**G2308**  
Special  
Order

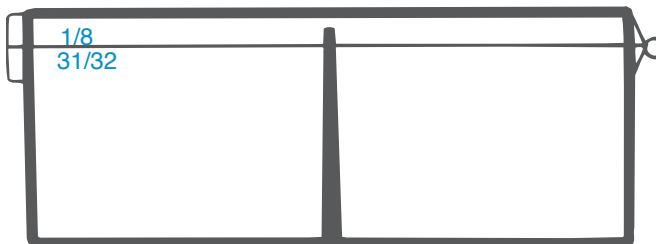

$1\frac{1}{16}''$

**7<sup>3/8</sup>" x 4<sup>29/32</sup>"**

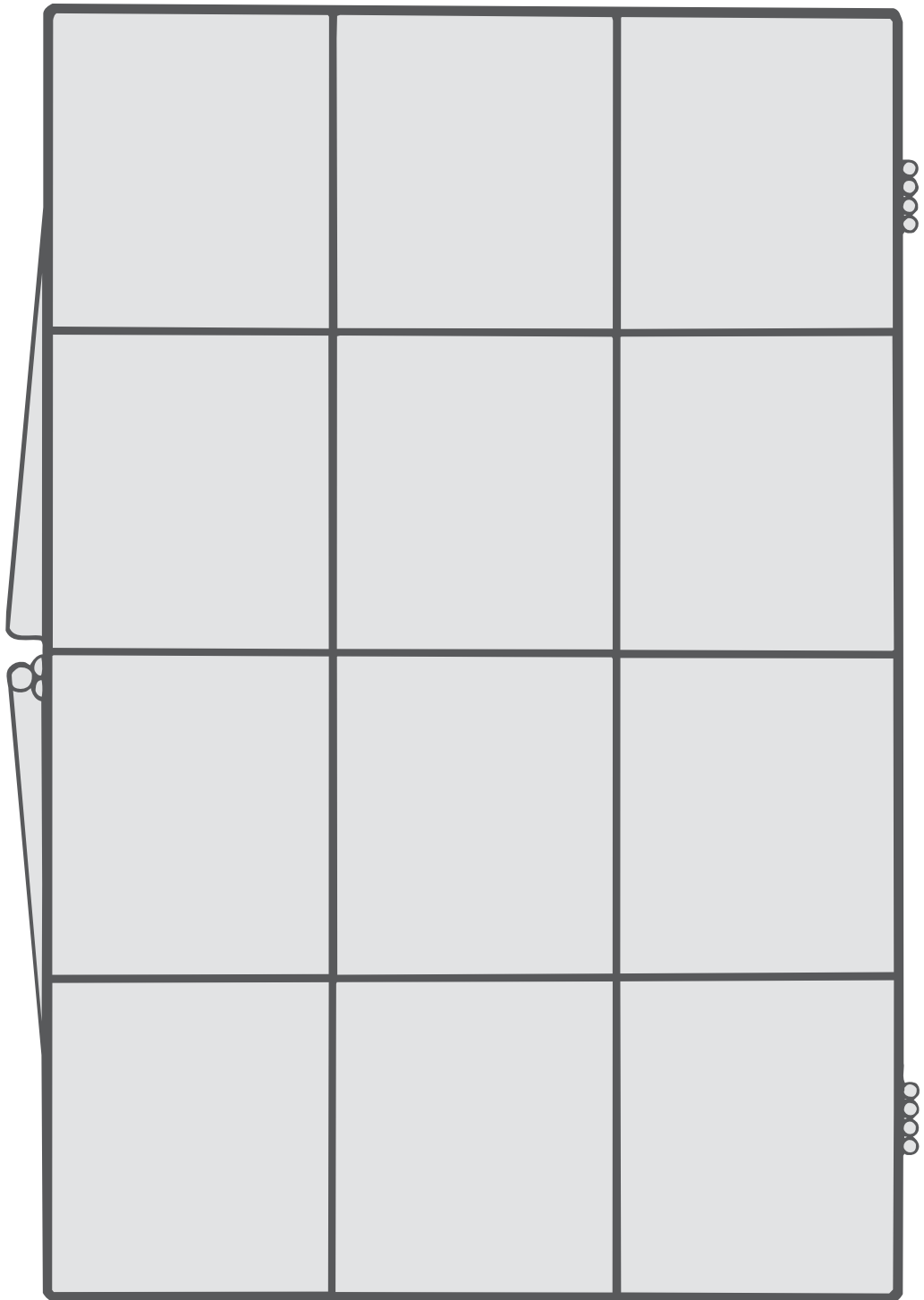

**G1940**  
Stockline

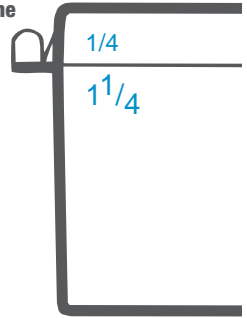

**1 1/2"**

**Twelve Compartments**



# 70 | Stock Compartment Containers

7" x 5"

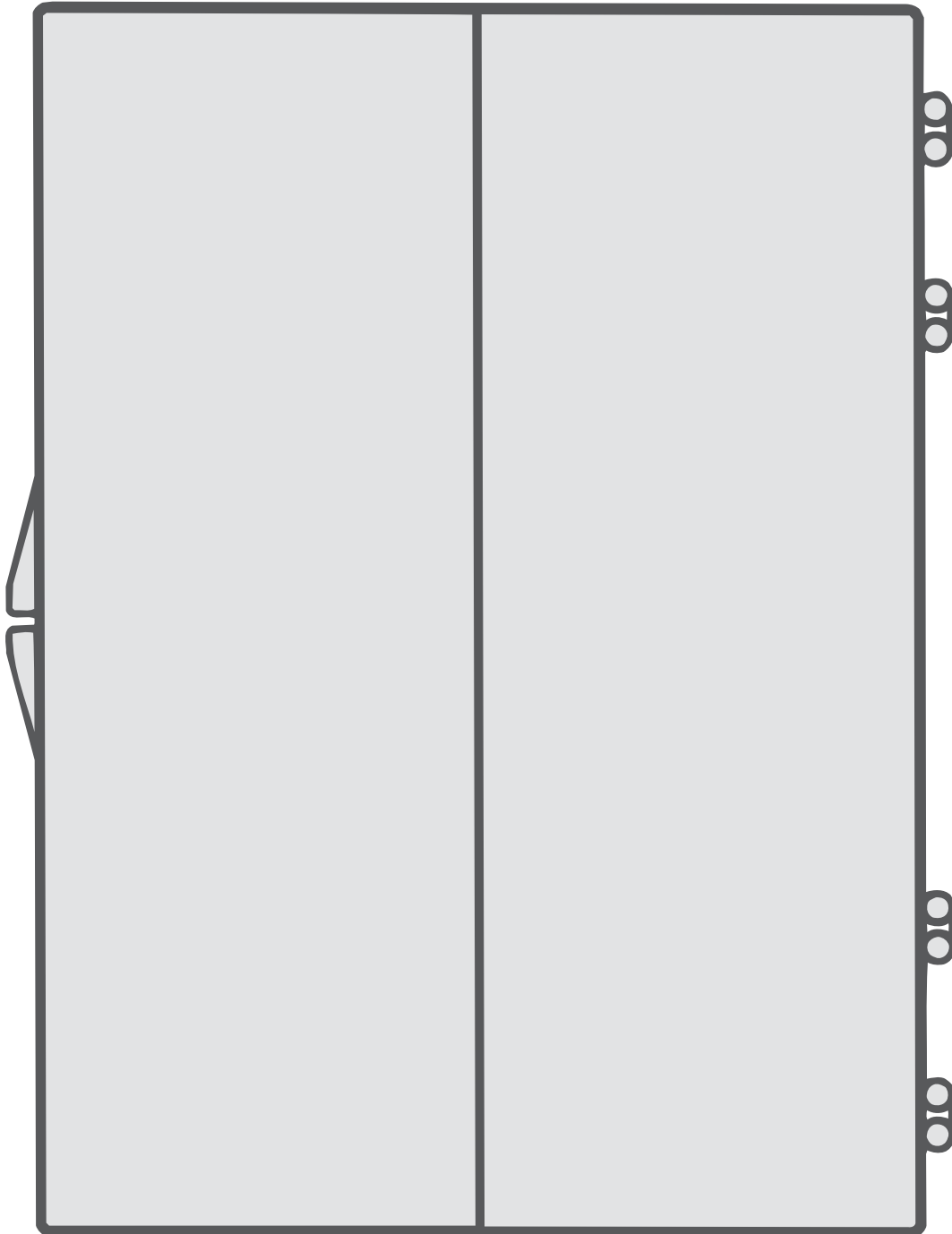

Two Compartments

**G2122**  
Special  
Order

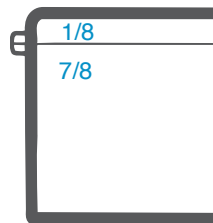

1"

**Pin Hinged**

**8" x 4"**

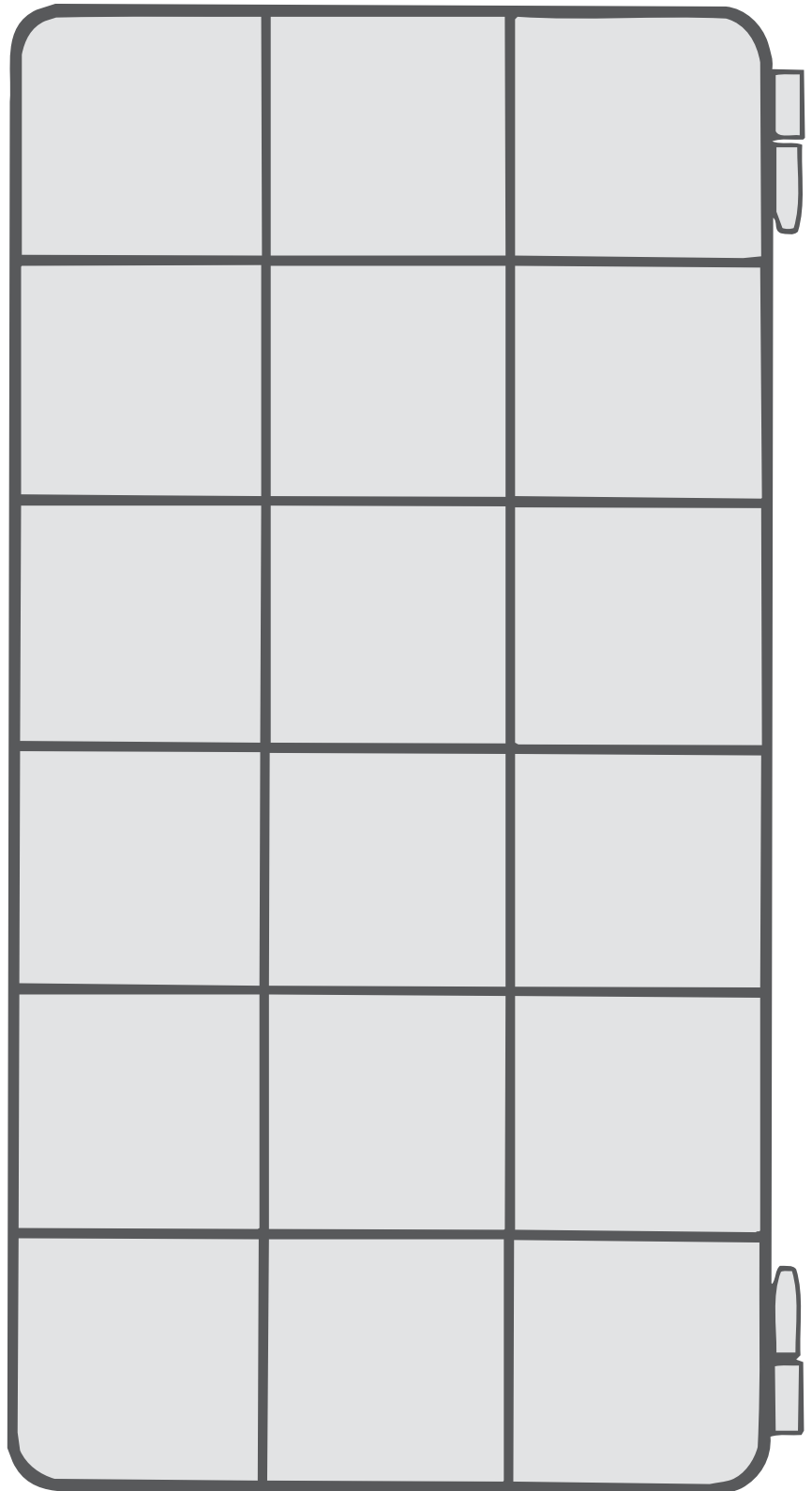

**48718**  
Stockline

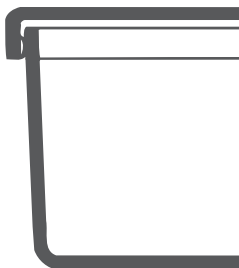

**1 1/4"**

**Eighteen Compartments**

**10<sup>3/8</sup>" x 6" Metal Hinged**

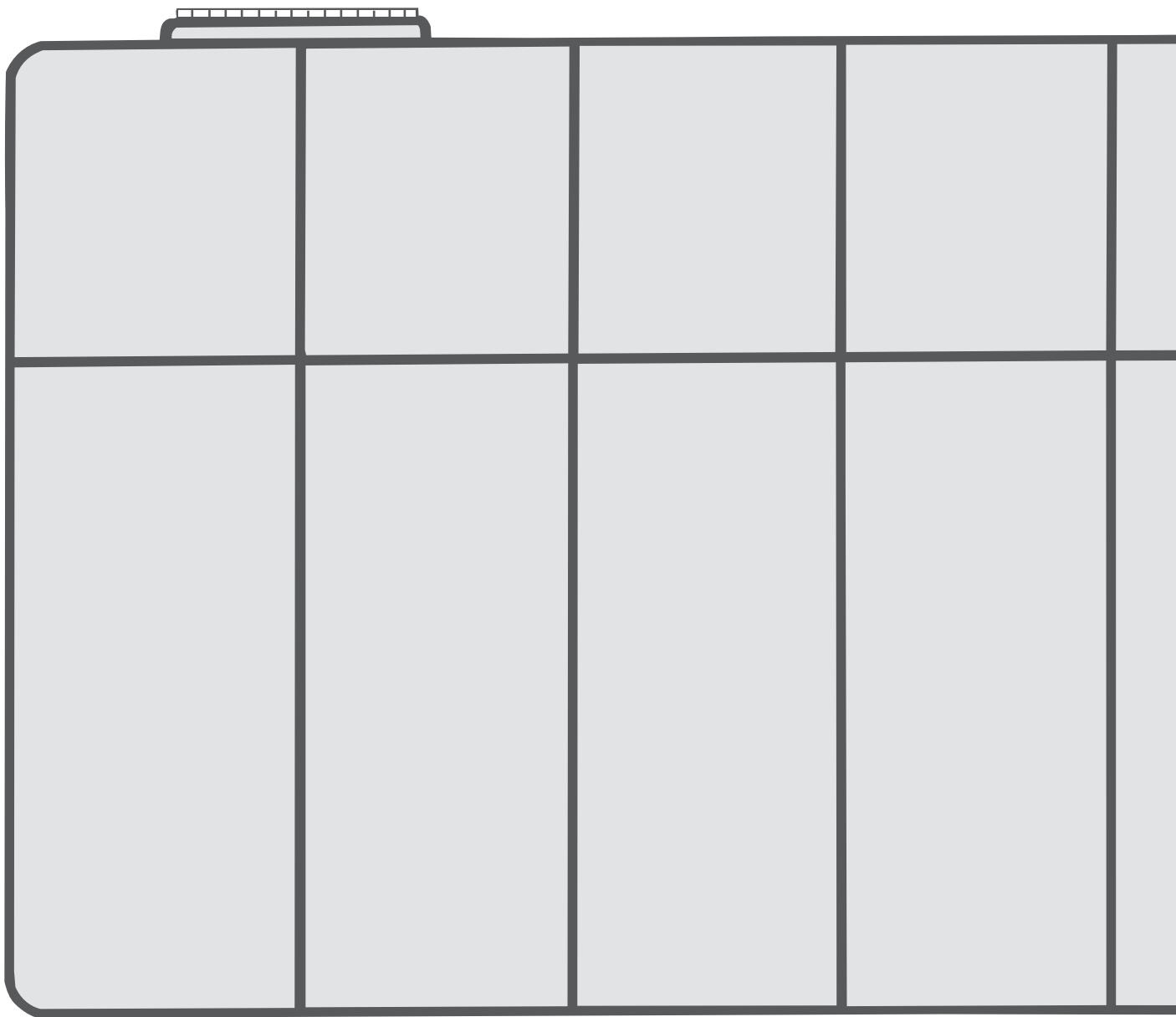

**Twelve Compartments**

**10<sup>3</sup>/<sub>8</sub>" x 6"**



**G2612**

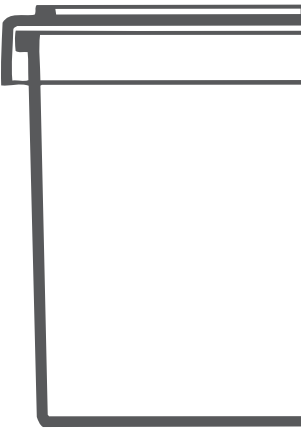

**2"**

# 74 | Stock Compartment Containers

10<sup>3/8</sup>" x 6" Metal Hinged

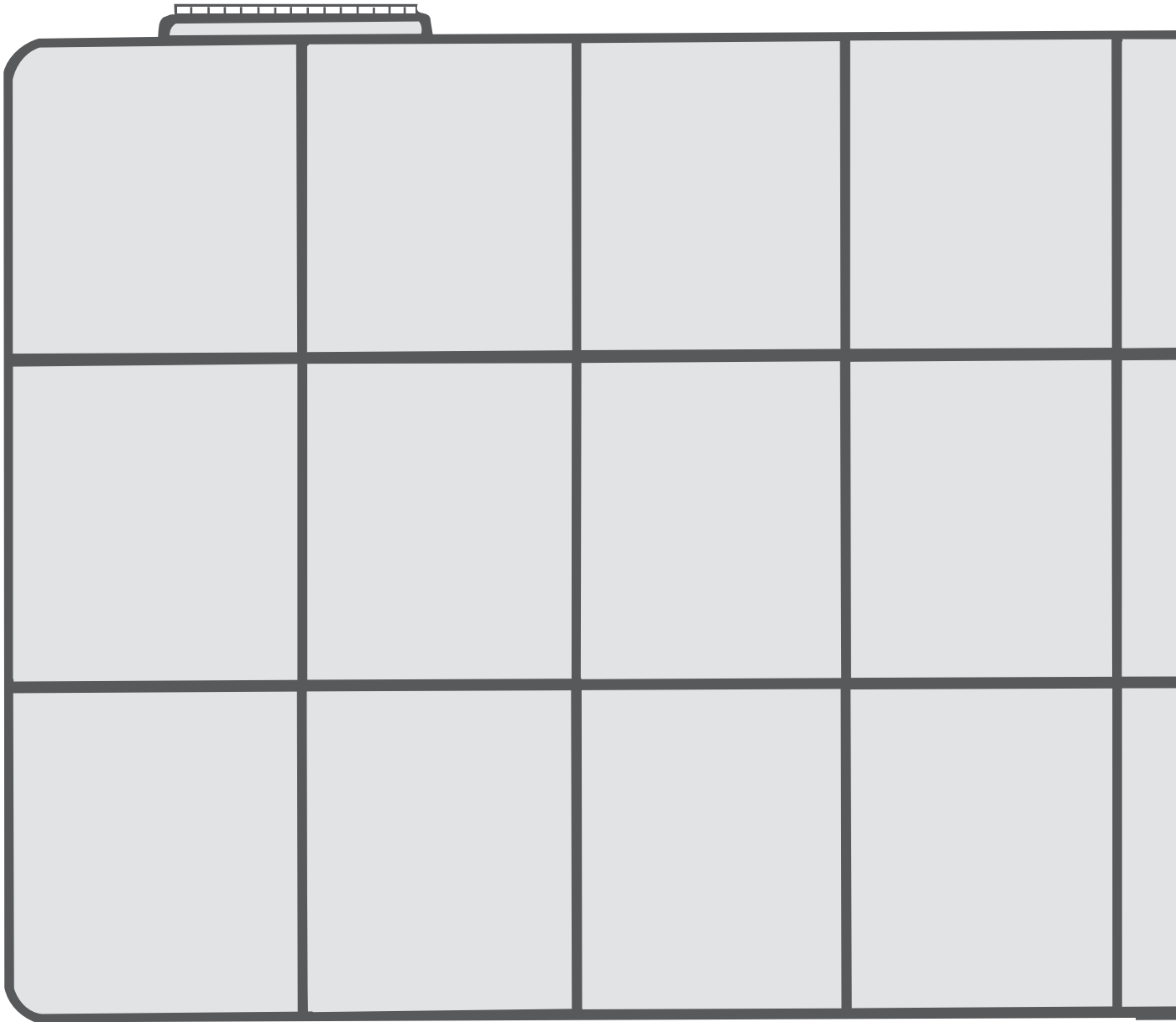

**Eighteen Compartments**

**10<sup>3</sup>/<sub>8</sub>" x 6"**

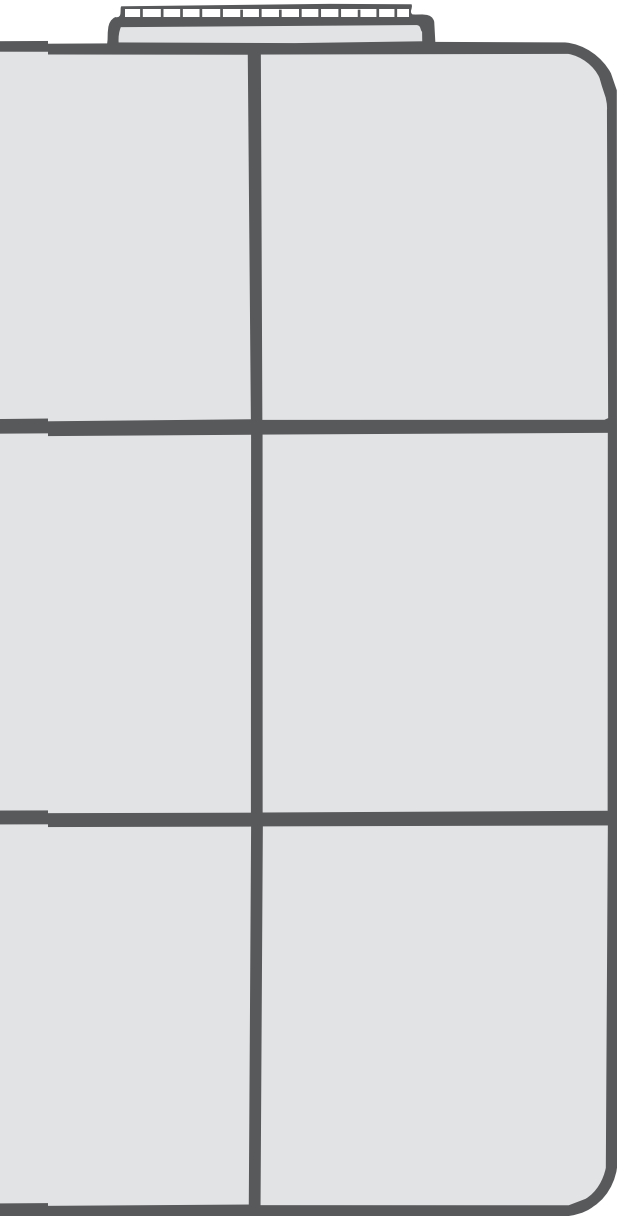

**G2618**

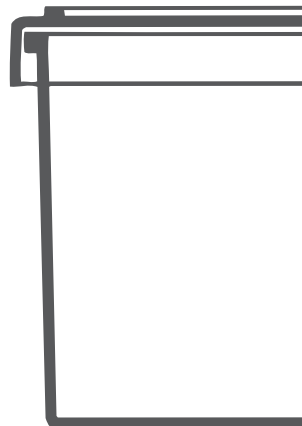

**2"**

# 76 | Omni Collection

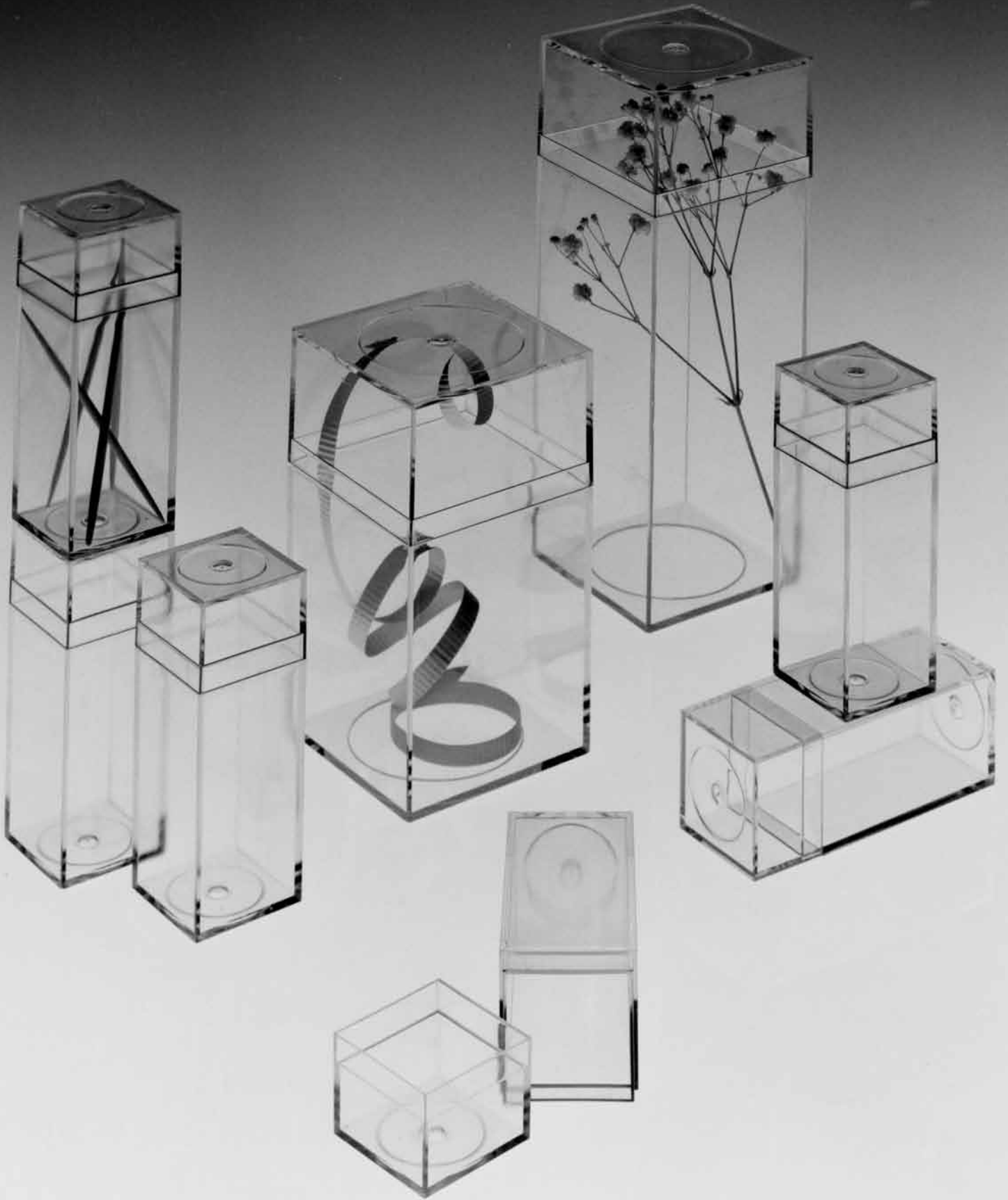

**1<sup>3/16</sup>" x 1<sup>3/16</sup>"**

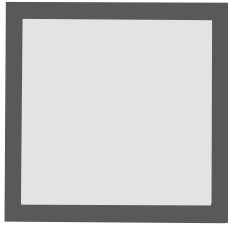

**1<sup>7/16</sup>" x 1<sup>7/16</sup>"**

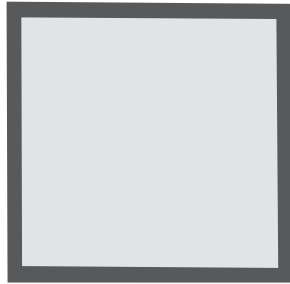

**1<sup>5/8</sup>" x 1<sup>5/8</sup>"**

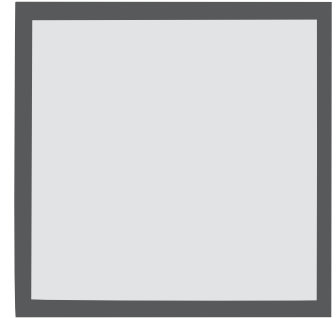

**531**  
Stockline

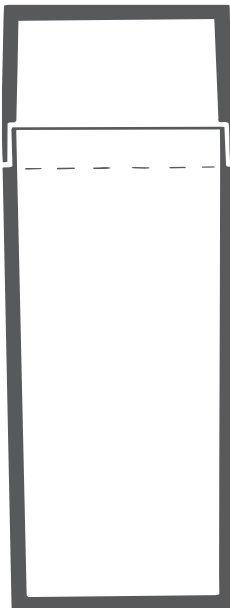

**3<sup>1/8</sup>"**

**539**  
Stockline

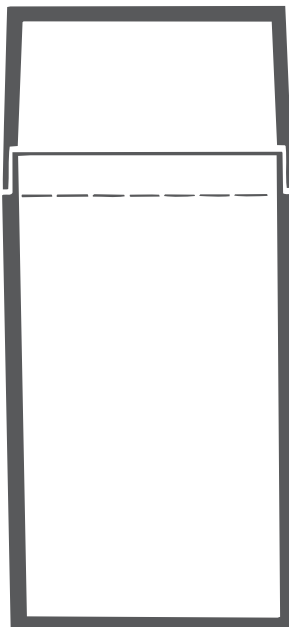

**3<sup>5/16</sup>"**

**543**  
Stockline

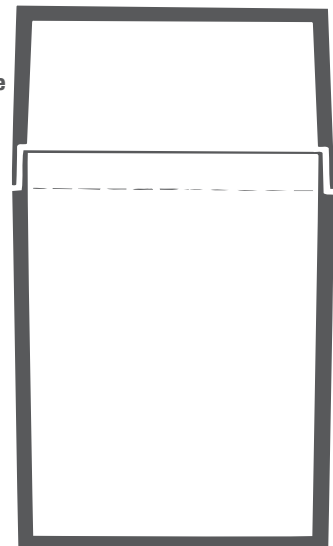

**2<sup>7/8</sup>"**



**2<sup>5</sup>/<sub>16</sub>" x 2<sup>5</sup>/<sub>16</sub>" Series**

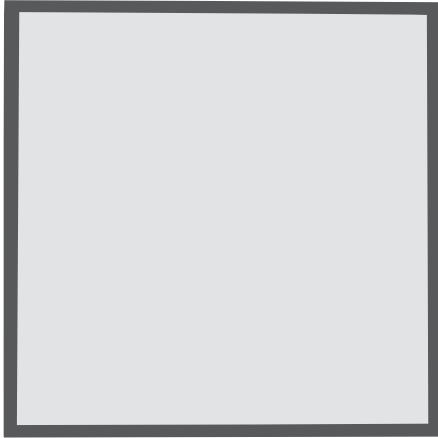

**Top View**

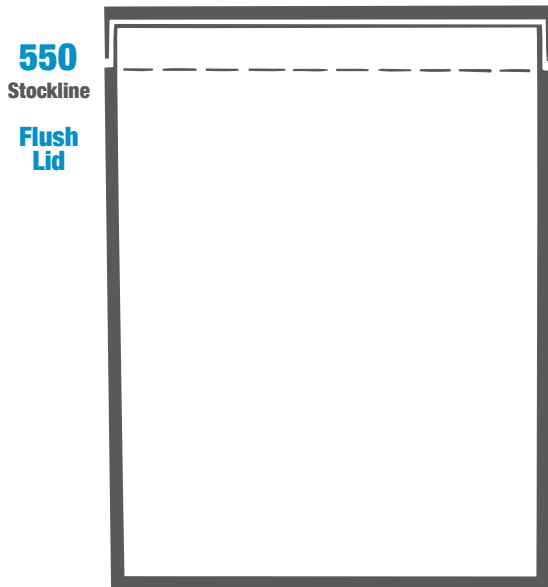

**550**  
Stockline  
**Flush**  
Lid

**3<sup>1</sup>/<sub>16</sub>"**

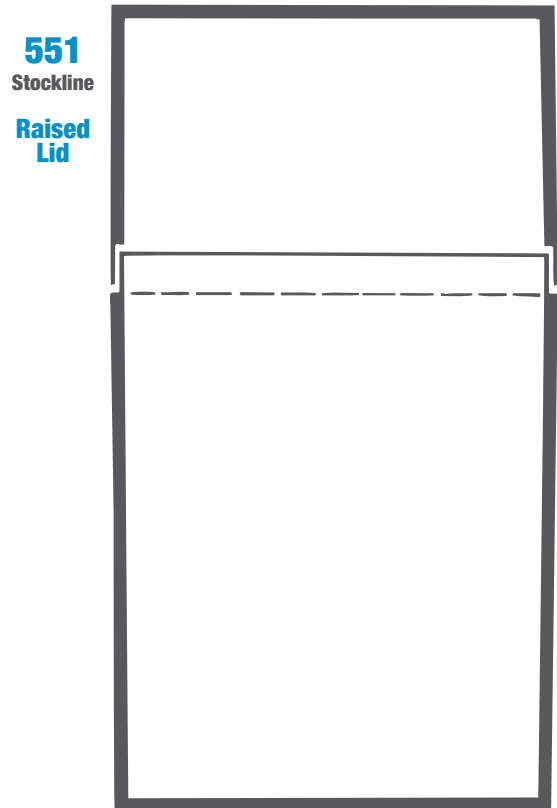

**551**  
Stockline  
**Raised**  
Lid

**4<sup>3</sup>/<sub>16</sub>"**

**552**  
Stockline  
Flush  
Lid

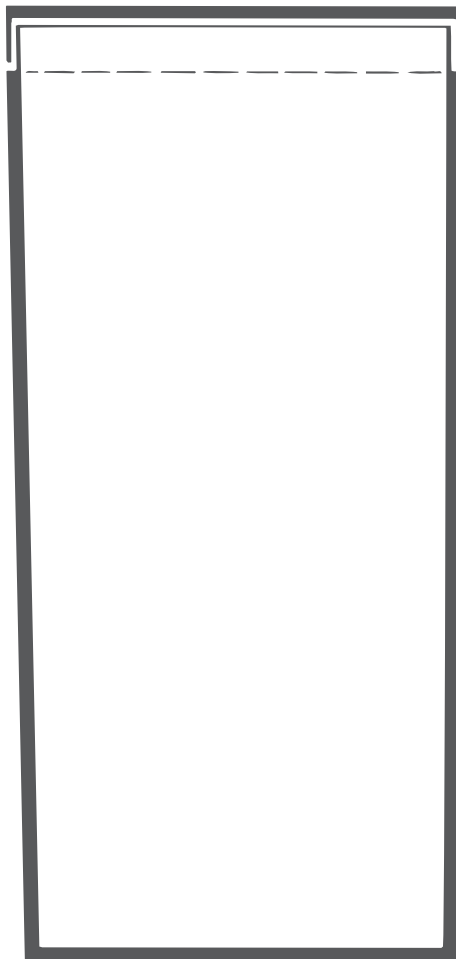

$5\frac{1}{16}$ "

**553**  
Stockline  
Raised  
Lid

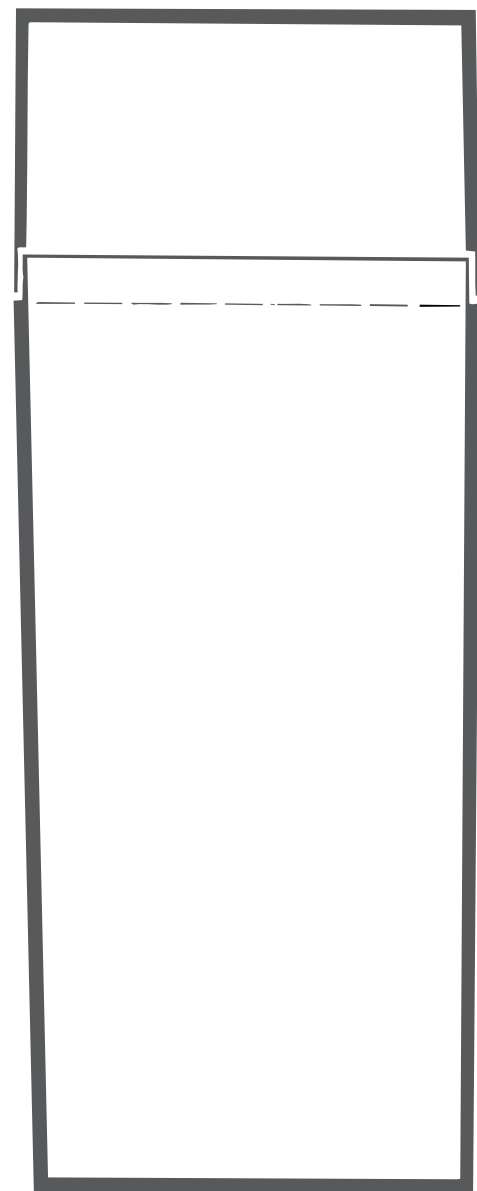

$6\frac{3}{16}$ "

# 80 | Omni Collection

Outside Dimensions

**3<sup>9</sup>/<sub>16</sub>" X 3<sup>9</sup>/<sub>16</sub>"**

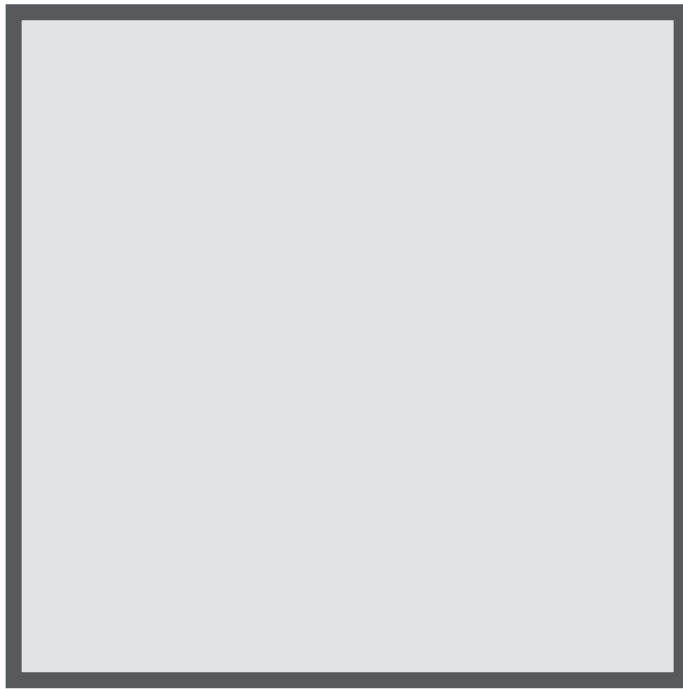

**558**  
Stock  
Line

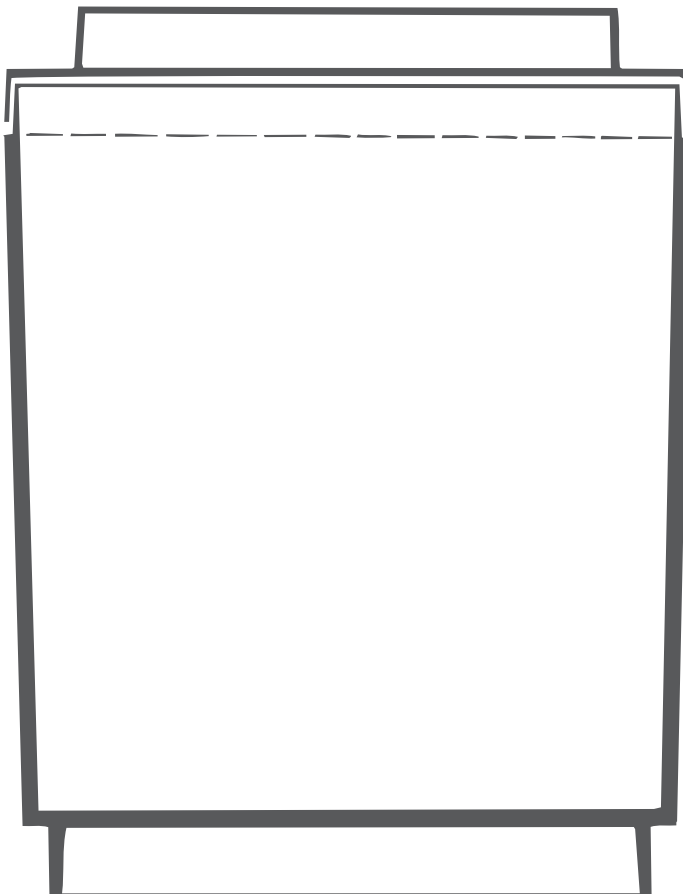

**3<sup>7</sup>/<sub>8</sub>"**

3<sup>7</sup>/<sub>16</sub>" X 3<sup>7</sup>/<sub>16</sub>"

535  
Stockline

Raised  
Lid

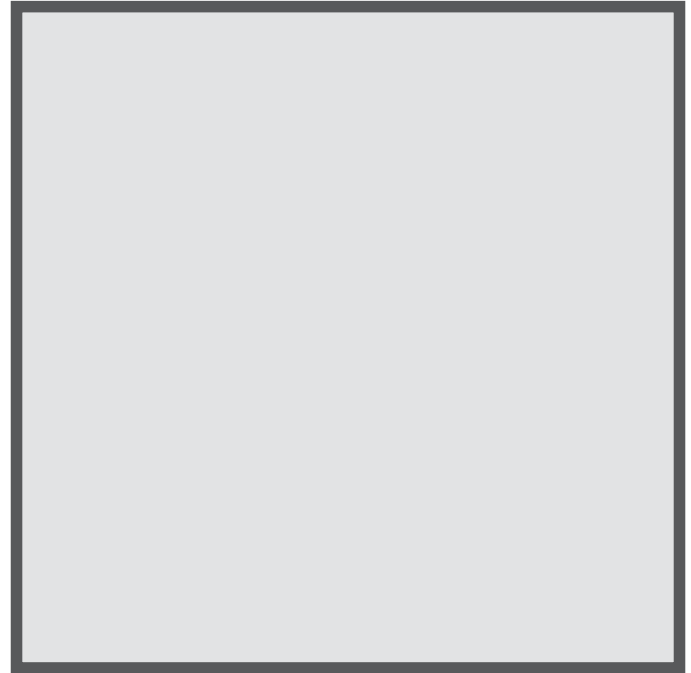
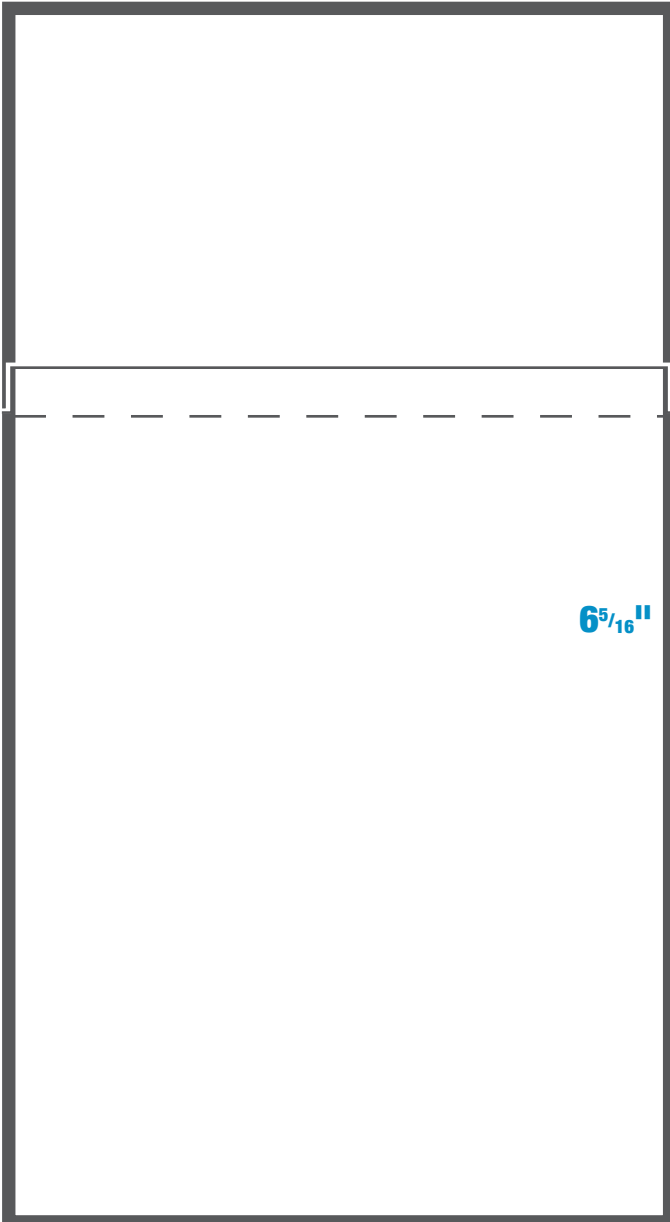

536  
Stockline

Flush  
Lid

Top View

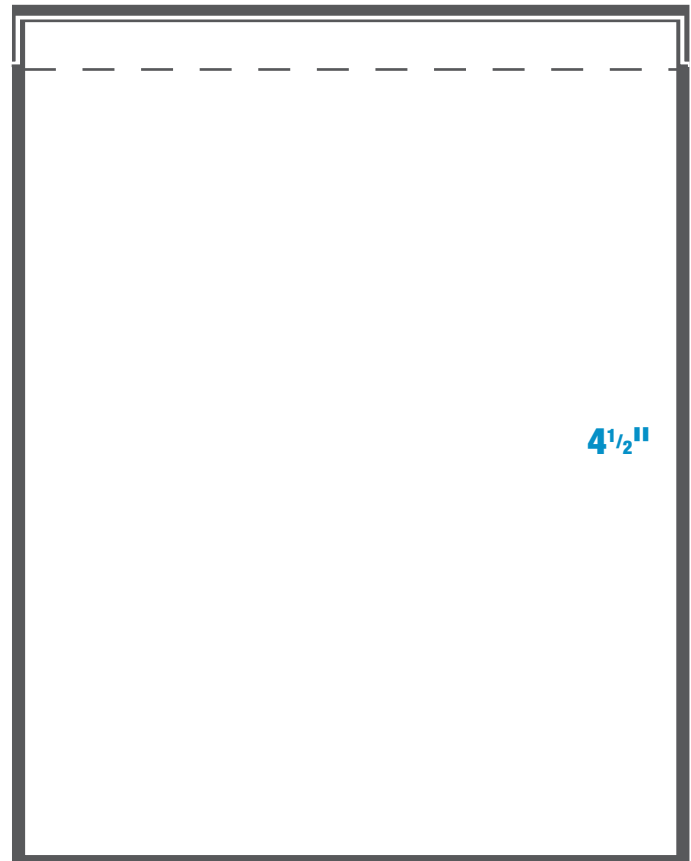

**4" x 4" Series**

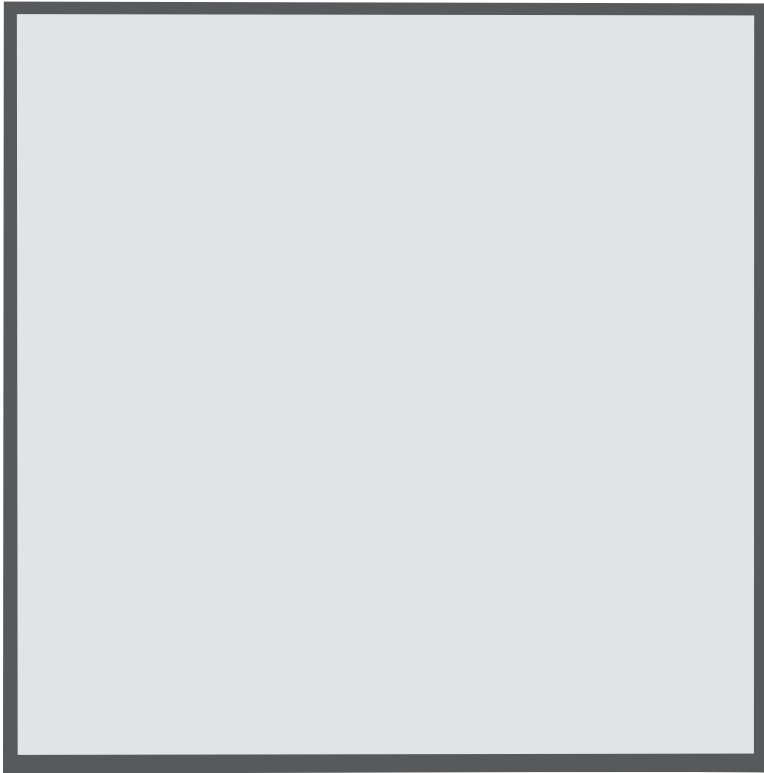

**Top View**

**566**

Stockline

**Flush  
Lid**

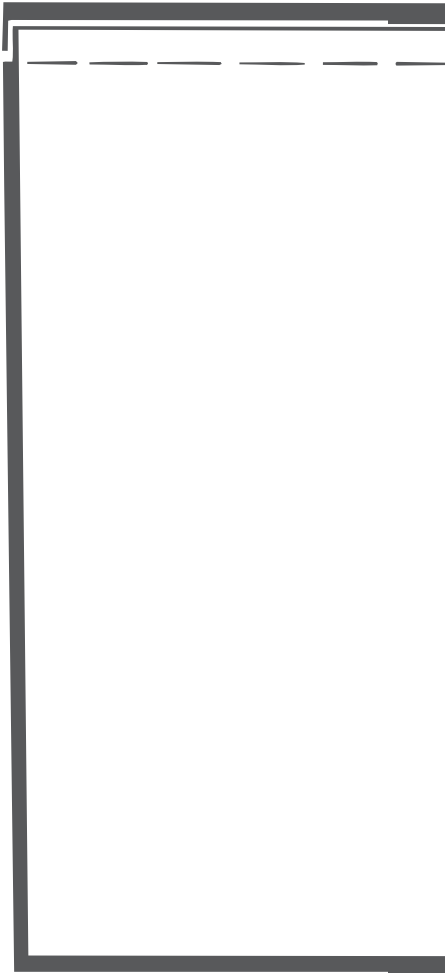

**565**

Stockline

**4<sup>1</sup>/<sub>4</sub>" with  
Raised Lid**

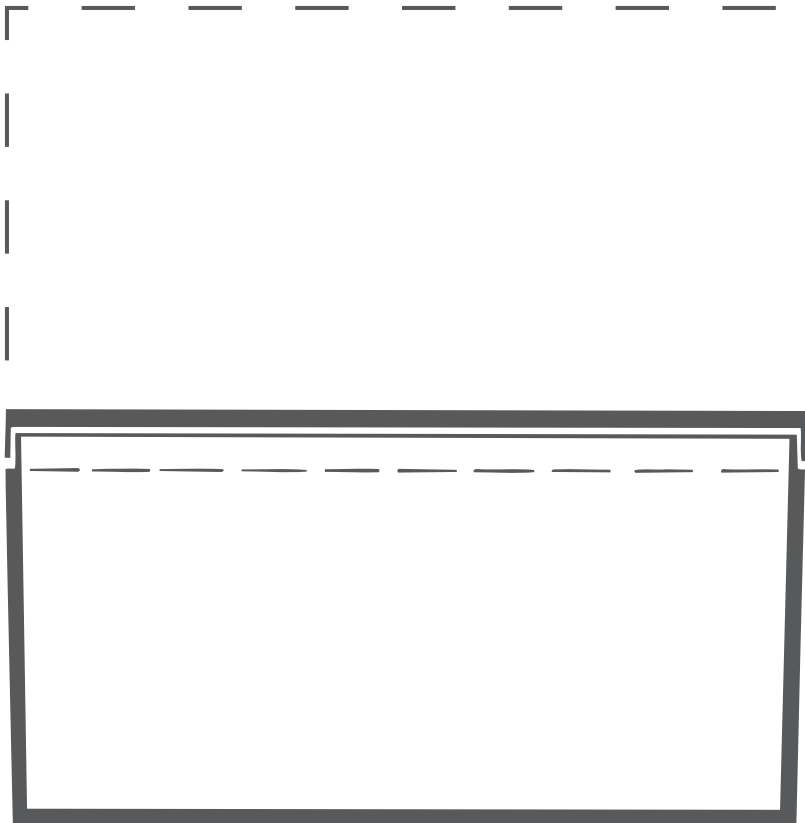

**564**

Stockline

**Flush  
Lid**

**2"**

**4" x 4"**

**567**  
Stockline  
Raised  
Lid

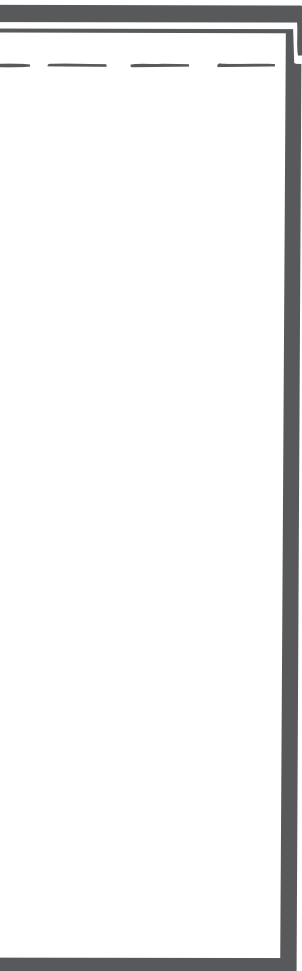

**5 1/16"**

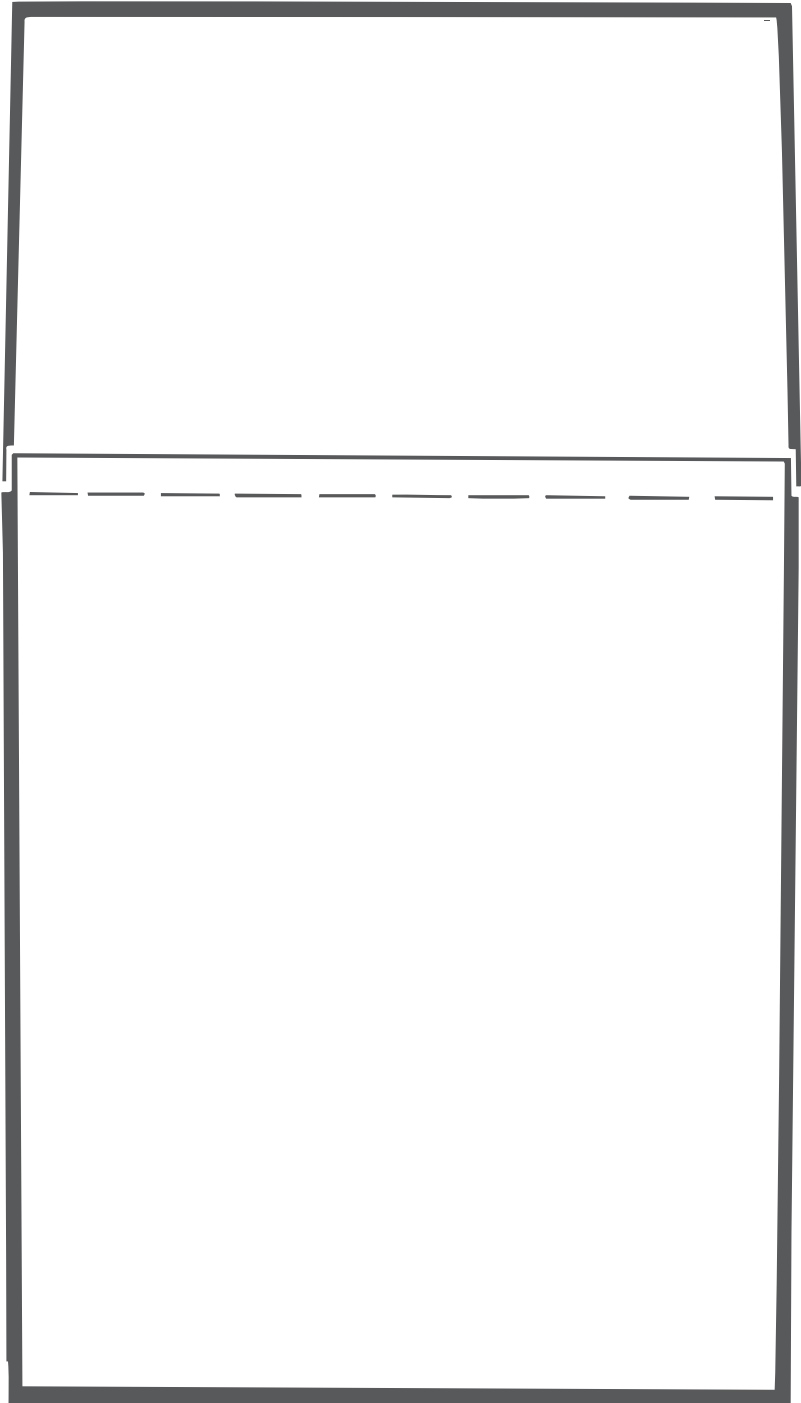

**7 1/4"**

# 84 | Omni Collection

Outside Dimensions

## 4" x 4" Series



Top View

**540**

Stockline

Flush Lid

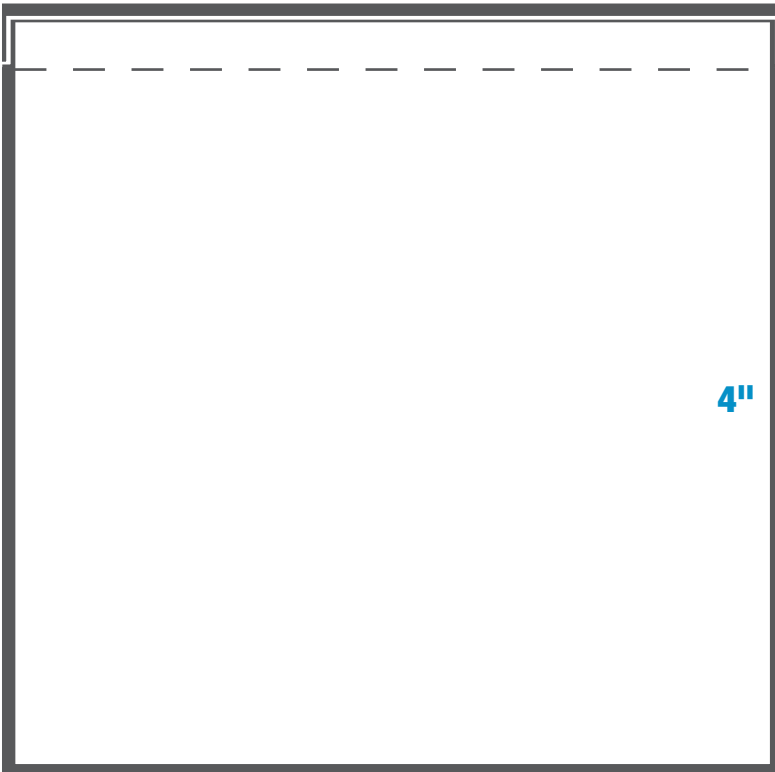

4"

**571**

Stockline

Raised Lid

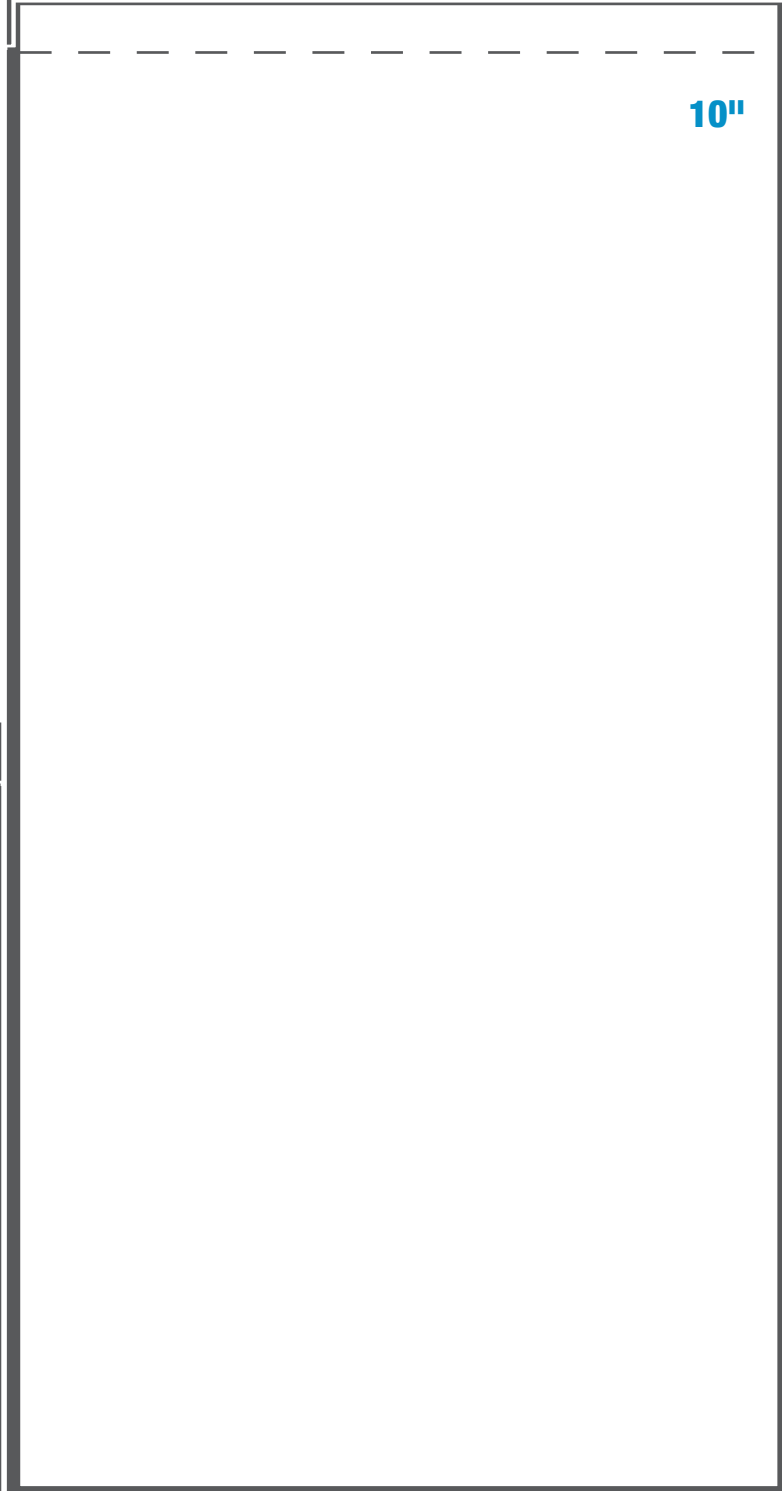

10"

# 4" x 4" Series

**570**  
Stockline

Flush  
Lid

**541**  
Stockline

Raised  
Lid

8"

6"



**4" x 8"**



**580**

Stockline

**Top View**

**Flush  
Lid**



**4"**

**12<sup>5</sup>/<sub>8</sub>" x 8<sup>7</sup>/<sub>8</sub>" Series**



Top View

Display case  
will stack in  
vertical and  
horizontal  
position

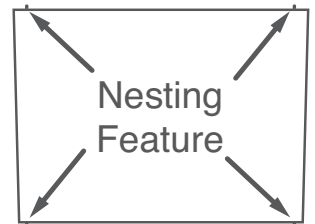

Nesting  
Feature



Horizontal position

**800**  
Stockline

Flush  
Lid



**9<sup>1</sup>/<sub>16</sub>"**

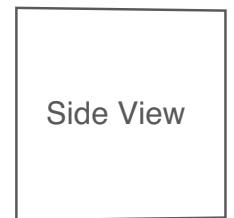

Side View

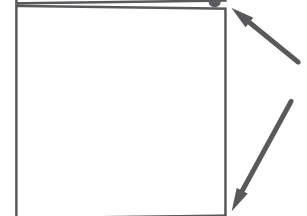

Vertical View

Shown @ 40% of actual size

## POLYPROPYLENE LIVING-HINGE CONTAINERS

L x W x H

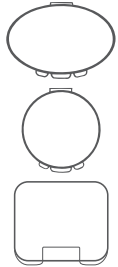

Style **6020** Oval **Stock**

**1<sup>3/4</sup>" x 1<sup>1/8</sup>" x 7/16"**

Style **706R** Round **Stock**

**1<sup>3/8</sup>" Dia. x 5/16"**

Style **8210** Pocket Size Box **Stock**

**3<sup>3/4</sup>" x 3<sup>1/4</sup>" x 1"**

## SQUEEZE BOTTLES available with and without lids lids must be ordered separately

W x H



Style **2003** 20 oz. **Stock**

**2<sup>3/4</sup>" Dia. x 6<sup>3/4</sup>"**

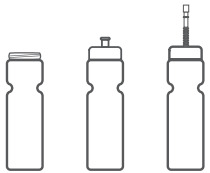

Style **2002** 28 oz. **Stock**

**2<sup>3/4</sup>" Dia. x 9"**



Style **2001** 32 oz. **Stock**

**3<sup>1/8</sup>" Dia. x 9"**

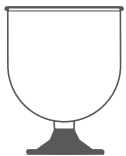

## DISPLAY GOBLET

L x W x H

Style **6070** **Stock**

**7<sup>5/8</sup>" x 6<sup>3/4</sup>" x 6<sup>3/4</sup>"**

### Products and Services Available:

Rigid Boxes • Die Cut Foam • Ethers & Esters • Sonic Welding • Hot Stamping • Silk Screen • Pad Print • Pack-out • Assembly • Warehouse and Dropship Program • Custom Injection Molding • Tooling & Fixtures • Complete Art & Design Department



Gary Plastic Packaging Corp. manufactures an extensive line of box styles and sizes for packaging and display. Over 350 styles and sizes of hinged, unhinged, round, compartment and Omni display boxes are available from stock tooling. Most are inventoried in crystal clear and tutone black for immediate delivery. All sizes are available in custom colors.

A rigid plastic package from Gary is recyclable & reusable, unlike paper or vacuum formed packaging. The clarity of the box and it's value enhances the product contained. Let us work with you to design an attention - getting package with maximum shelf appeal.

To further enhance your package, four color spot or process printing is now available on all our boxes. Fine detail, sharp images, perfect registration and PMS color matches are all achieved on the latest model pad printing and silk screening equipment. We ship you a complete package. Fill it and you are ready to go to market.

New from Gary. SPORTS SQUEEZE BOTTLES plain and decorated up to 6 colors.  
Call customer service for information.

**Gary Plastic Packaging Corp.** 1340 Viele Avenue, Bronx, NY 10474 • 718-893-2200 • Fax 877-855-5554 • 800-221-8150  
www.plasticboxes.com • Email: sales@plasticboxes.com